



User's Manual

FULL DC INVERTER

air source heat pump (R290)

Before operating the product, please read the manual carefully and keep this manual for future use.

Content

1. Preface	- 1 -
1.1. Product features	- 1 -
2. Safety rules	- 2 -
3. Working principle	- 5 -
4. Dimensional drawing	- 6 -
4.1. Product size and profile	- 6 -
4.2. Exploded view	- 8 -
4.3. Appearance	- 8 -
5. Installation	- 13 -
5.1. Installation drawing	- 13 -
5.2. Materials required for the installation	- 16 -
5.3. Installation location	- 16 -
5.4. Installation details	- 17 -
5.5. Accessories	- 19 -
5.6., Electrical connection	- 20 -
5.7. Water circulation connection	- 24 -
5.8. Transportation	- 25 -
5.9. Trial run	- 25 -
6. Maintenance	- 26 -
6.1. Cleaning of the water filter	- 28 -
6.2. Cleaning of the plate heat exchanger	- 28 -
6.3. The refrigerant charge	- 28 -
6.4. Cleaning of the evaporator	- 28 -
6.5. Maintenance of the outdoor unit	- 28 -
7. Electrical wiring diagram	- 28 -
8. Technical parameters	- 35 -
9. Performance curves	- 37 -
10. Display operation guide	- 53 -
10.1. Controller panel	- 53 -
10.2. Display icon	- 53 -
10.3. Definition of buttons	- 54 -
10.4. Wire controller operation	- 55 -
10.5. User parameter query & setting	- 62 -
10.6. Restore factory settings	- 64 -
10.7. High temperature antiseptis function	- 65 -
10.8. Target temperature auto adjustment logic (under heating mode)	- 66 -

10.9. Auxiliary electric heater for water tank	- 66 -
10.10. Auxiliary electric heater for space heating	- 67 -
10.11. General operating guide	- 67 -
10.12. Users' guide	- 67 -
11. Failure list & troubleshooting	- 70 -
11.1. Controller error codes	- 70 -
11.2. Owner inspection	- 72 -
11.3. Troubleshooting	- 73 -

1. Preface

R290 FULL DC INVERTER air source heat pump transfers heat from ambient air to water to provide high temperature hot water up to 70°C. This high-temperature heat pump is widely used for heating. With innovative and advanced technology, the heat pump can operate at an ambient temperature of -25°C and operate at an output temperature of up to 70°C, ensuring compatibility with conventional-sized radiator-based systems without the need to supplement other equipment. Compared with traditional fuel/LPG boilers, the carbon dioxide emissions of R290 FULL DC INVERETR air source heat pump can be reduced by 50% and the operation cost can be saved by 80%.

R290 FULL DC INVERTER air source heat pump is a kind of efficient, energy saving, environmentally friendly equipment, used for indoor heating, cooling and domestic hot water. It can be used with any type of indoor unit, such as fan coil, radiator or floor heating pipe, to provide heating or hot water. The monobloc heat pump can also be used with multiple indoor units.

1.1. Product Features

- ① Low operating cost, high efficiency, energy efficiency coefficient (COP) up to 5.
- ② Reduce costs, easy to install
- ③ High comfort, by increasing the water storage temperature to increase the hot water supply time, to ensure the comfort of users.
- ④ A digital controller was integrated to maintain the water temperature.
- ⑤ Corrosion resistance and long life, with excellent weather resistance, can withstand harsh climatic conditions.
- ⑥ The efficient compressor ensures excellent performance, ultra-high energy efficiency, durability and quiet operation.
- ⑦ The self-diagnostic control panel monitors the heat pump operation and troubleshooting to ensure safe and reliable operation.
- ⑧ The smart digital controller has a friendly user interface and a blue LED backlight.
- ⑨ Independent isolated electrical compartments prevent internal corrosion and extend heat pump life.
- ⑩ The heat pump can operate at -25°C ambient temperature.

2. Safety Rules

Read and follow all the warnings and installation instructions before installing this product. If not following safety warnings and installation instructions, serious injury, death or property damage may happen.

The following symbols are very important. Be sure to understand their meaning, which involves the product and your personal safety.





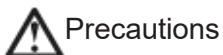







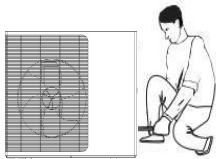

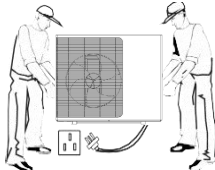



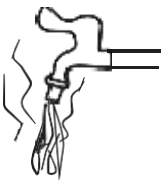

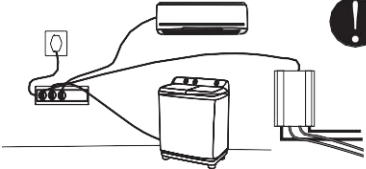

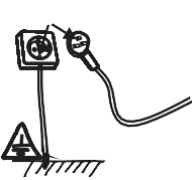
Warnings





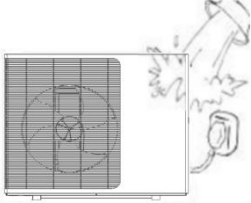

Precautions

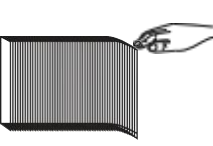

Prohibition

 	 	 
<p>The installation, disassembly and maintenance of the unit must be carried out by the professional after-sales personnel. Any changes to the structure of the unit are prohibited, personal injury or damage to the unit may happen.</p>	<p>To avoid electric shocks, please be prepared. Repair electrical parts, must disconnect the power supply for more than 1 minute. Even after 1 minute, use a multimeter to measure the voltage at the main power supply terminal. Before contact with a capacitor or electrical components, ensure that the voltage is below the human safety voltage.</p>	<p>Be sure to read this manual firstly.</p>
 	 	 
<p>To obtain clean hot water, always add a mixing valve in front of the faucet and set it to the appropriate temperature.</p>	<p>Please use a special socket, or a failure may occur.</p>	<p>The power supply supplied to the unit must be grounded.</p>
 	<p>The device is suitable for children aged 8 years above and adults, and should be used by other personnel under the supervision of a guardian with full capacity. Children are not allowed to play with the equipment, and children are not allowed to clean and maintain the equipment.</p>	
 	 	 

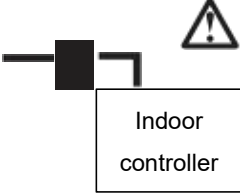
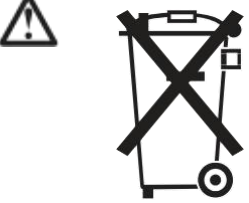
Do not touch the air outlet grille when the fan motor is running.	Do not touch the power plug with your wet hands.	Never pour water or any liquid into the product, which may cause the electrical leakage or failure of the product.
		
When the power cord is loose or damaged, please find a professional after-sales personnel for repair.	Please choose the correct fuse or circuit breaker according to the recommendations. Steel wire or copper wire cannot be used instead of fuses or circuit breakers. Otherwise, the damage maybe happen.	Be careful not to touch your fingers with the evaporator fins, or you may be cut by the fins.
		<p>Main power cable</p> 
Select the appropriate circuit breaker according to the rated current of the product.	Disposal of waste batteries (if any). please dispose it according to the local garbage classification specifications.	It is recommended to install residual current protector (RCD) with rated residual operating current not exceeding 30 mA.
<ol style="list-style-type: none"> 1 . It is recommended to fill the system with pure water. 2 . If filling with city water, soften the water and add a filter. 3 . Note: After filling, the water supply system shall be 0.15 ~ 0.6MPa. 		
	The sign indicates that the product should not be treated with other household waste throughout the EU region. In order to prevent uncontrolled waste disposal from harming the environment or human health, material resources should be recycled responsibly. To return the equipment you have used, use the recycling and collection system or contact the retailer who sold the product. They can dispose this product for environmentally friendly and safe recycling.	

! Warnings

- (1) This machine is not recommended to install by users, but must entrust an agent or a professional installation company authorized by the company to install, otherwise it may cause safety accidents and affect the use effect.
- (2) Except for the operation of professional personnel, non-professional personnel shall not dismantle the unit without authorization, otherwise an accident or damage to the unit may

occur.

- (3) Do not use or store flammable items such as hairspray, paint, gasoline, alcohol near this machine, otherwise it may cause fire.
- (4) The main power switch of the unit shall be placed in places inaccessible to children to prevent potential safety risks caused by children's contact with the power switch.
- (5) In thunderstorm weather, please cut off the main power switch of the unit, otherwise it may cause danger or damage to the unit.
- (6) The unit shall use an independent power switch to avoid sharing the same circuit with other electrical appliances. And select the current matching power line and circuit breaker (with leakage protection function) to supply power to the unit.
- (7) The unit must be installed with the grounding wire of the specified section. Do not connect the grounding wire with the grounding wire of the gas pipeline, water pipe, lightning protection line or telephone, and must be grounded reliably to avoid accidents.
- (8) Do not forcibly cut off the power supply during the unit operation to avoid accidents.
- (9) When the unit is not used for a long time, please drain the water in the pipeline, and close the water pipe valve. And disconnect the main power supply switch to avoid accidents.
- (10) The unit shall use a special power supply, and the power supply voltage shall meet the rated voltage standard.
- (11) When the power cord is damaged, the power cord specified by the manufacturer must be used and replaced by professional maintenance personnel.



Precautions

- (1) Do not put your hand or foreign matters into the air outlet, otherwise the high-speed fan may endanger personal safety.
- (2) Do not remove the air guide net cover of the unit, otherwise the high-speed running fan may cause harm to personnel.
- (3) Lightning and other electromagnetic radiation sources may affect this machine, if this happens, cut off the power and then power it on again.
- (4) When being used, ensure that the air in the pipeline is completely removed, and then open the water filling valve to replenish the water system again.
- (5) Before operating the machine, read all the warnings and precautions carefully.
- (6) Warnings and Precautions list all safety-related priorities.
- (7) The working environment of the unit should be far away from the fire source. If the fire is caused by wiring problems, cut off the main switch immediately and use the dry powder fire extinguisher to extinguish the fire.
- (8) The power supply must be cut off before repairing the unit.
- (9) It is forbidden to place objects above the unit to avoid accidents caused by falling objects when the machine runs.

3. Working Principle

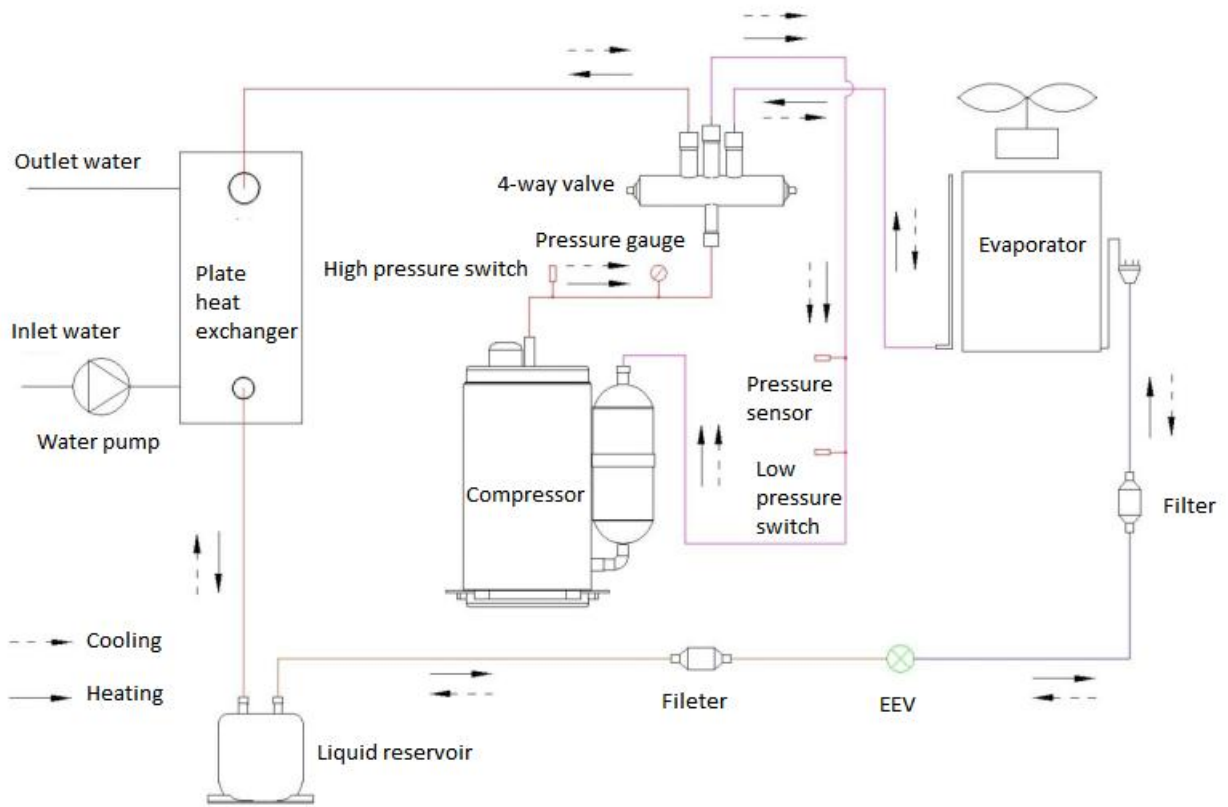

4. Dimensional Drawing

4.1. Product Size and Profile

PW030-DKZLRS-E/S

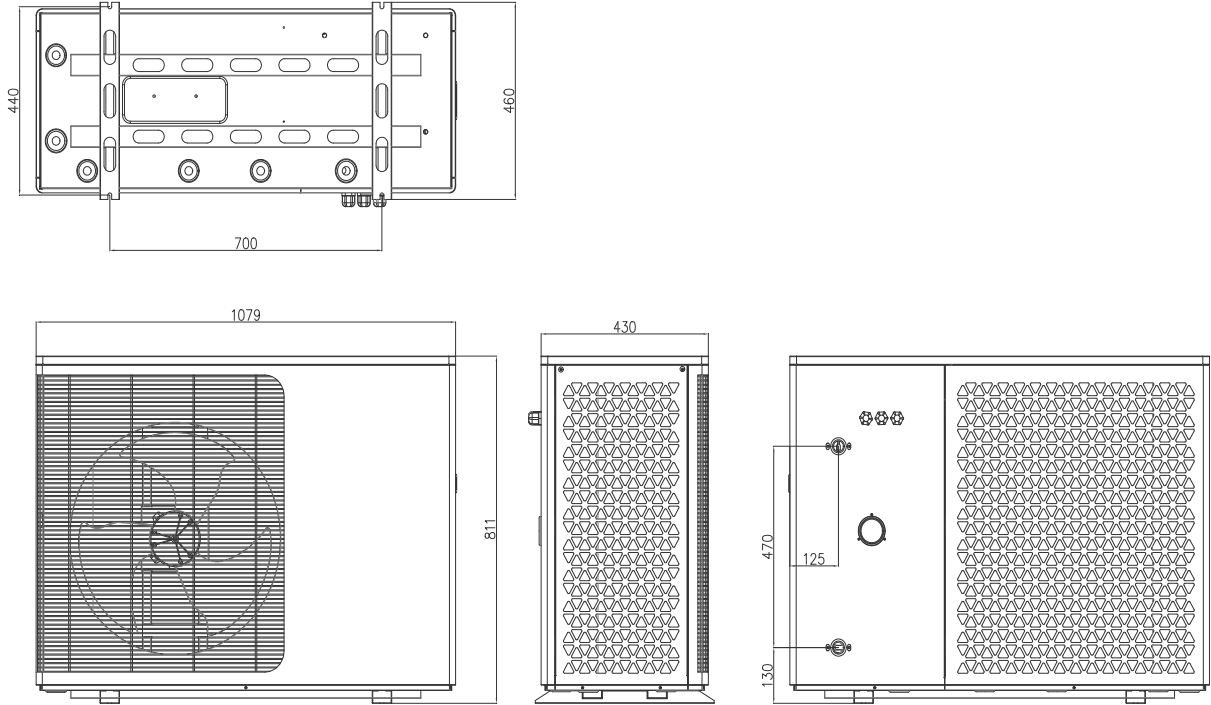

PW040-DKZLRS-E/S

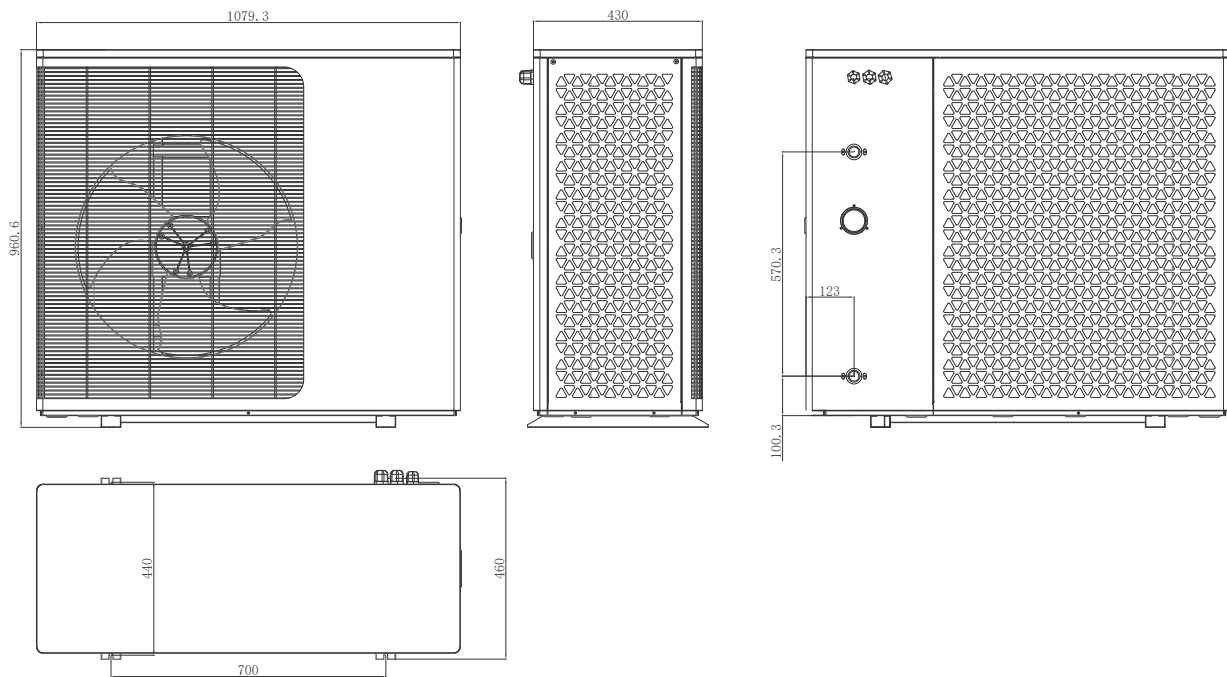

PW050-DKZLRS-E PW050-DKZLRS-E/S

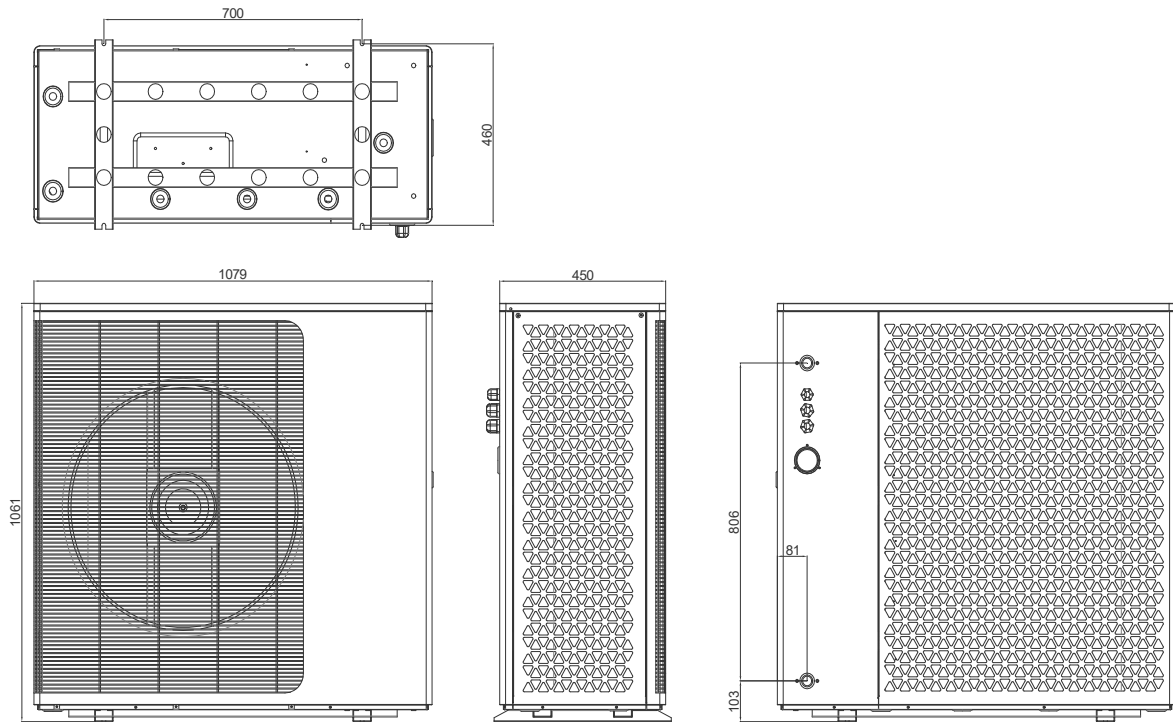

PW060-DKZLRS-E

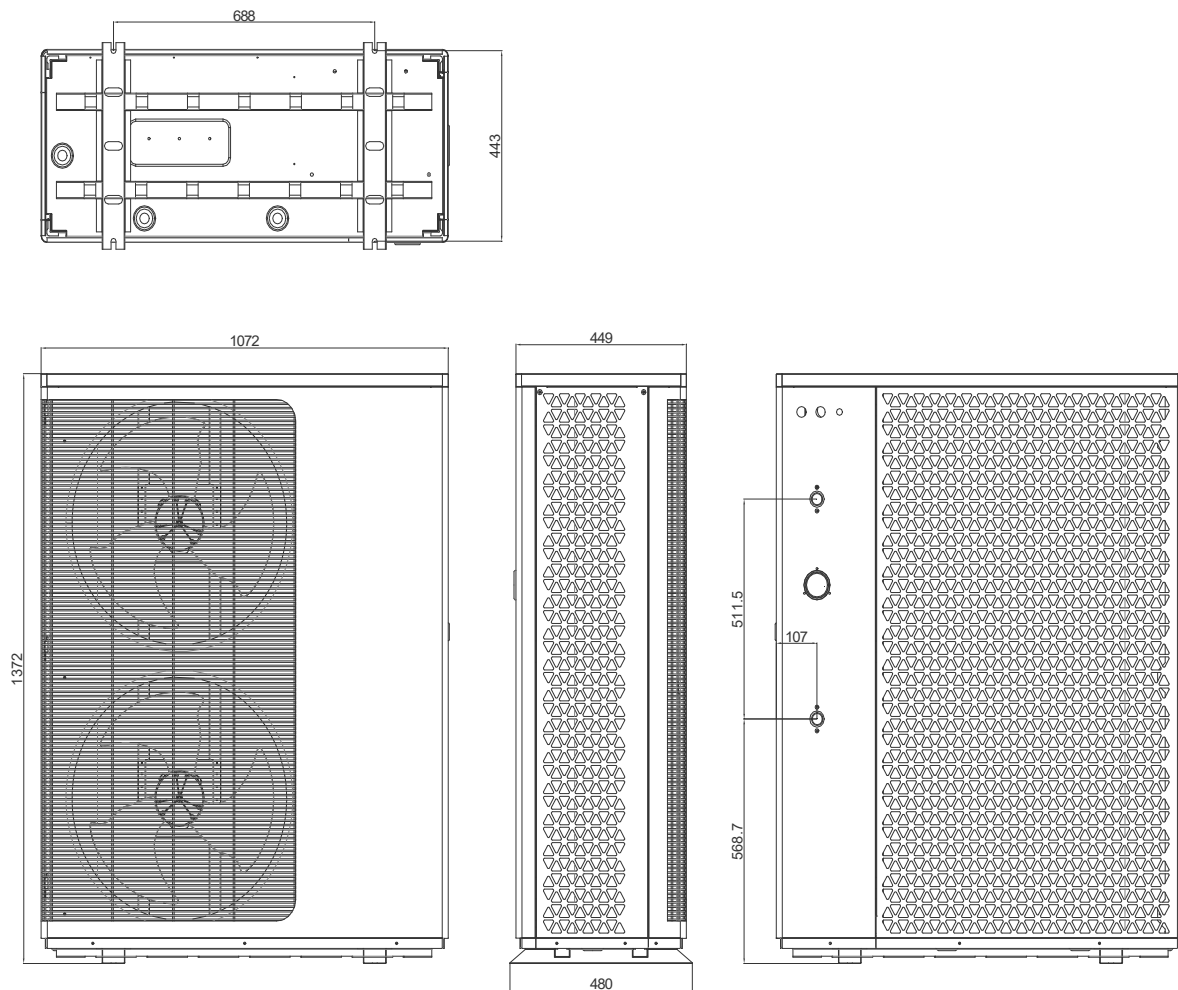

4.2. Exploded View

PW030-DKZLRS-E/S PW040-DKZLRS-E/S

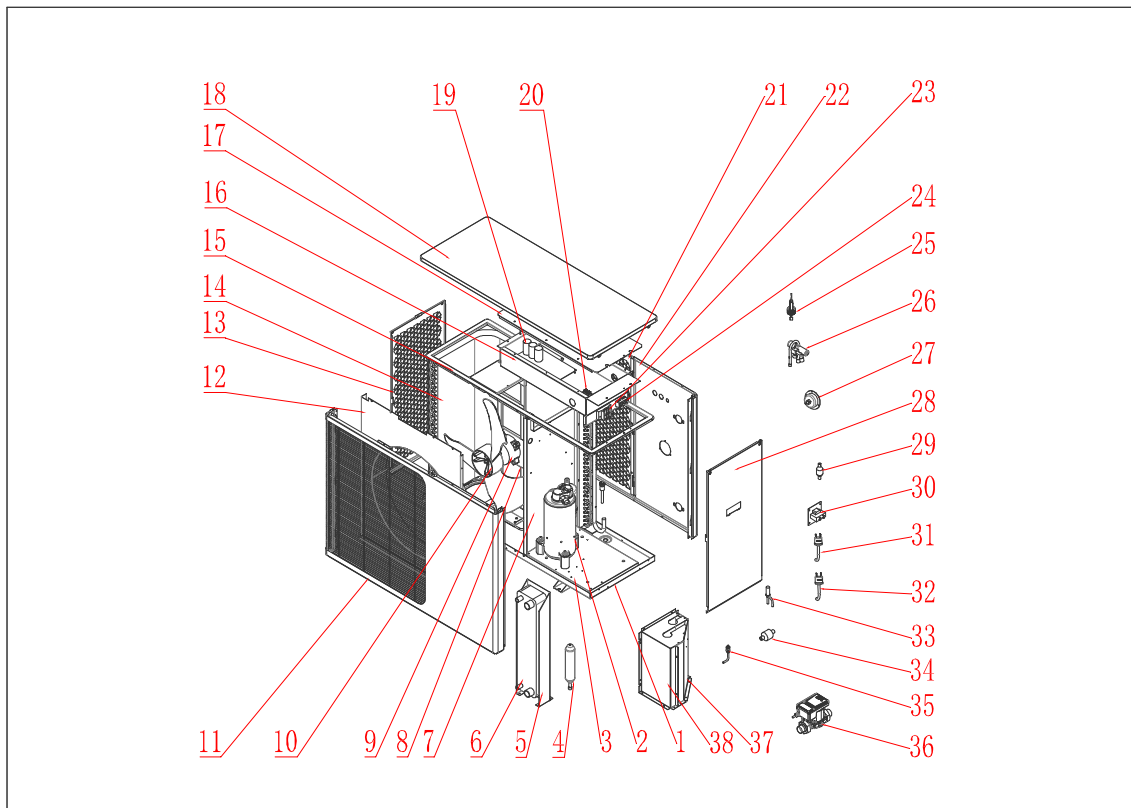

NO	Spare parts	NO	Spare parts
1	chassis	21	back net
2	compressor	22	rear side panel
3	damping plate	23	terminal block
4	liquid storage tank	24	terminal block
5	plate replacement support	25	water flow switch
6	plate heat exchanger	26	4-way valve
7	center spacer	27	pressure gauge
8	motor bracket	28	right side panel
9	motor	29	drying filter
10	fan blade	30	reactance
11	front panel	31	high voltage switch
12	Air guide panel	32	low voltage switch
13	left net	33	electronic expansion valve
14	fin heat exchanger	34	filter
15	top frame	35	needle valve
16	electric box	36	water pump
17	electric box cover	37	compressor hood 1
18	top panel	38	compressor hood 2
19	driver board		
20	transfer terminal block		

PW050-DKZLRS-E/S PW050-DKZLRS-E

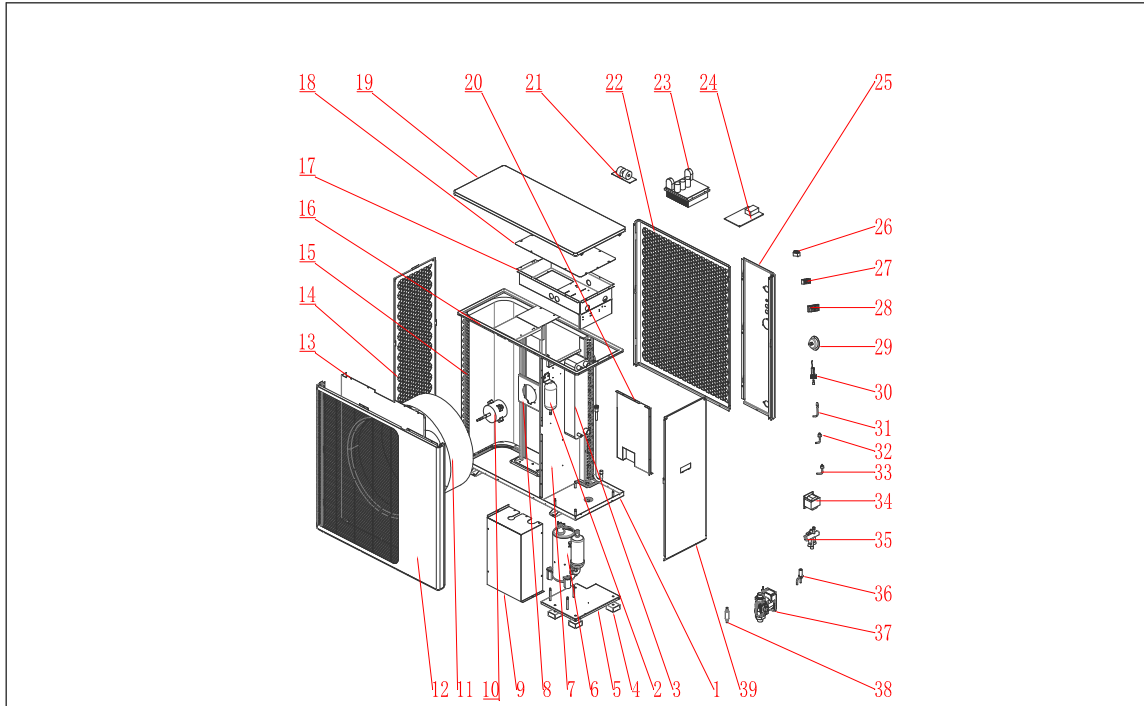

NO	Spare parts	NO	Spare parts
1	chassis	21	filter board
2	liquid storage tank	22	back net
3	plate heat exchanger	23	driver board
4	rubber pad	24	control board
5	damping plate	25	rear side panel
6	compressor	26	transfer terminal block
7	center spacer	27	transfer terminal block
8	motor bracket	28	transfer terminal block
9	dlimp	29	pressure gauge
10	motor	30	water flow switch
11	fan blade	31	needle valve
12	front panel	32	high voltage switch
13	Air guide panel	33	low voltage switch
14	left net	34	reactor
15	fin heat exchanger	35	4-way valve
16	top frame	36	electronic expansion valve
17	electric box	37	water pump
18	electric box cover	38	check valve
19	top panel	39	right side panel
20	dlimp		

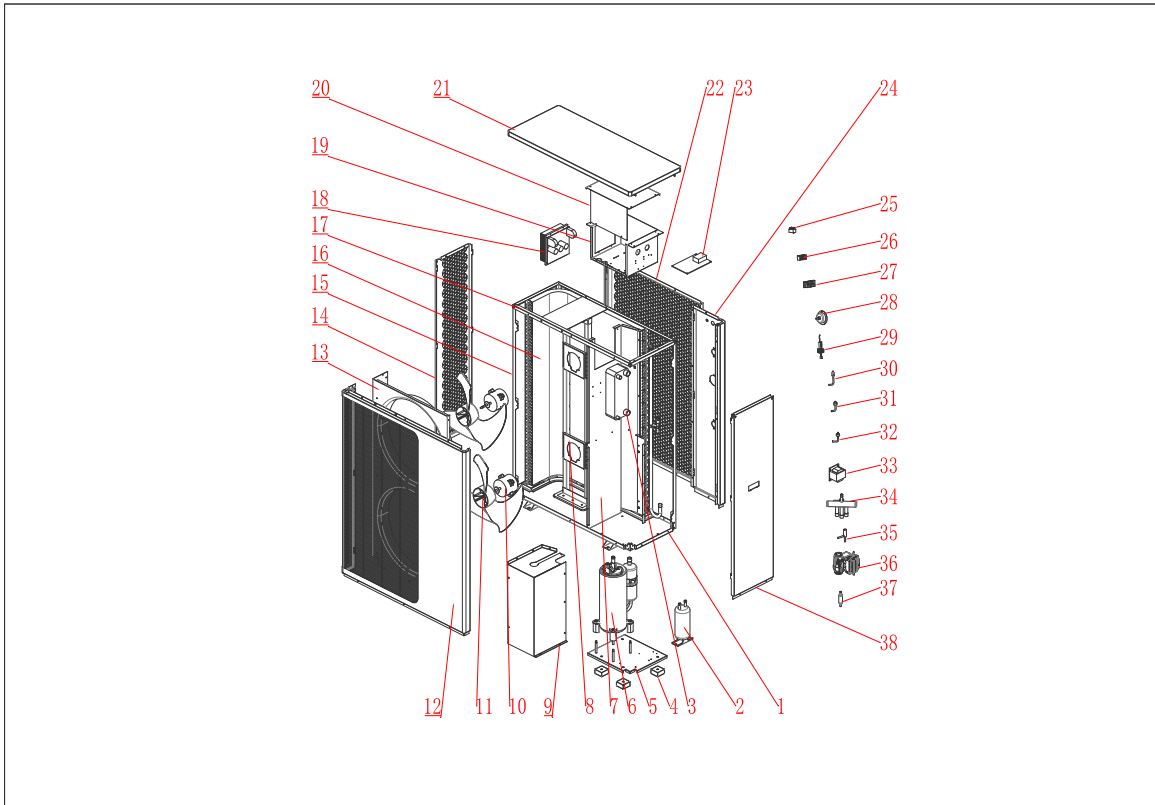

NO	Spare parts	NO	Spare parts
1	chassis	21	top panel
2	liquid storage tank	22	back net
3	plate heat exchanger	23	control board
4	rubber pad	24	rear side panel
5	damping plate	25	transfer terminal block
6	compressor	26	transfer terminal block
7	center spacer	27	transfer terminal block
8	motor bracket	28	pressure gauge
9	dlimp	29	water flow switch
10	motor	30	needle valve
11	fan blade	31	high voltage switch
12	front panel	32	low voltage switch
13	Air guide panel	33	reactor
14	left net	34	4-way valve
15	post	35	electronic expansion valve
16	fin heat exchanger	36	water pump
17	top frame	37	check valve
18	driver board	38	right side panel
19	electric box		
20	electric box cover		

4.3. Appearance

PW030/040/050-DKZLRS-E/S PW050-DKZLRS-E

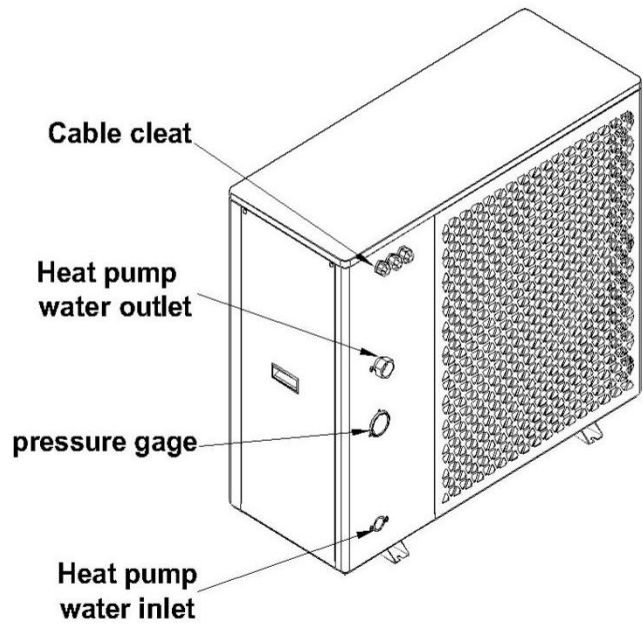
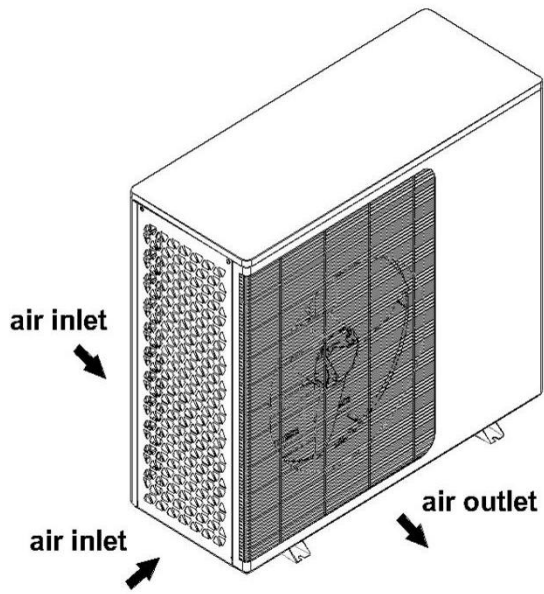

PW060-DKZLRS-E

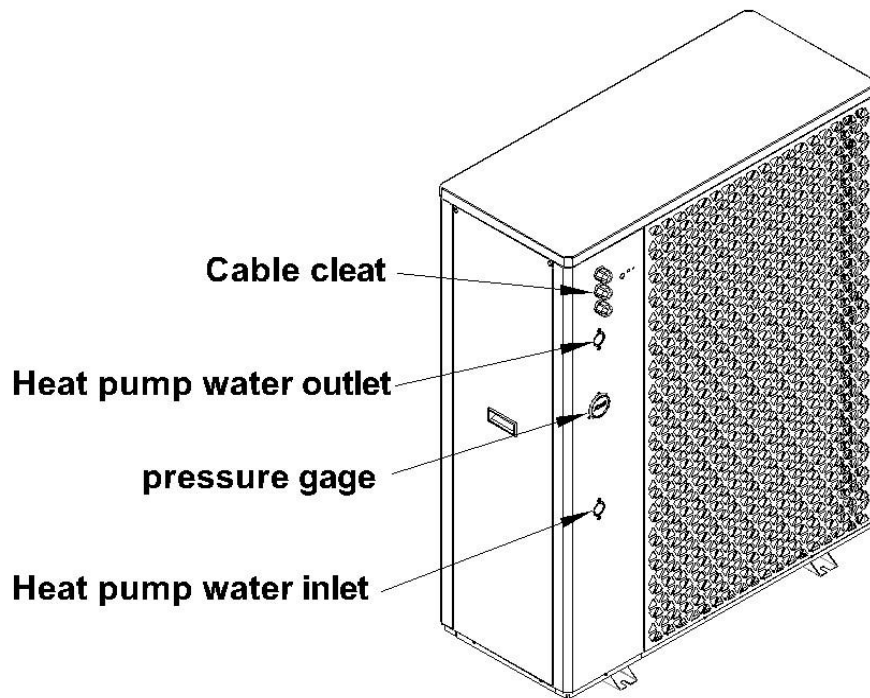
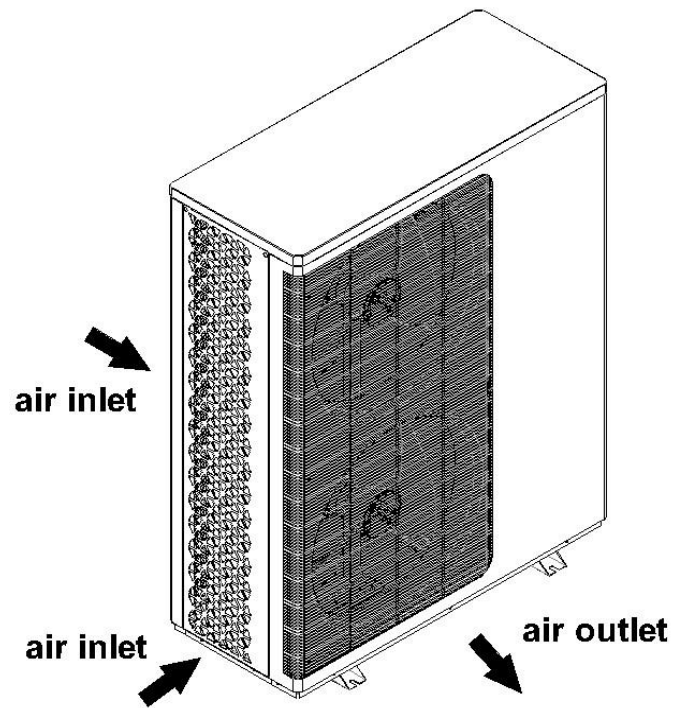

5. Installation

5.1. Installation Drawing

5.1.1. Heating, Cooling and Domestic Hot Water

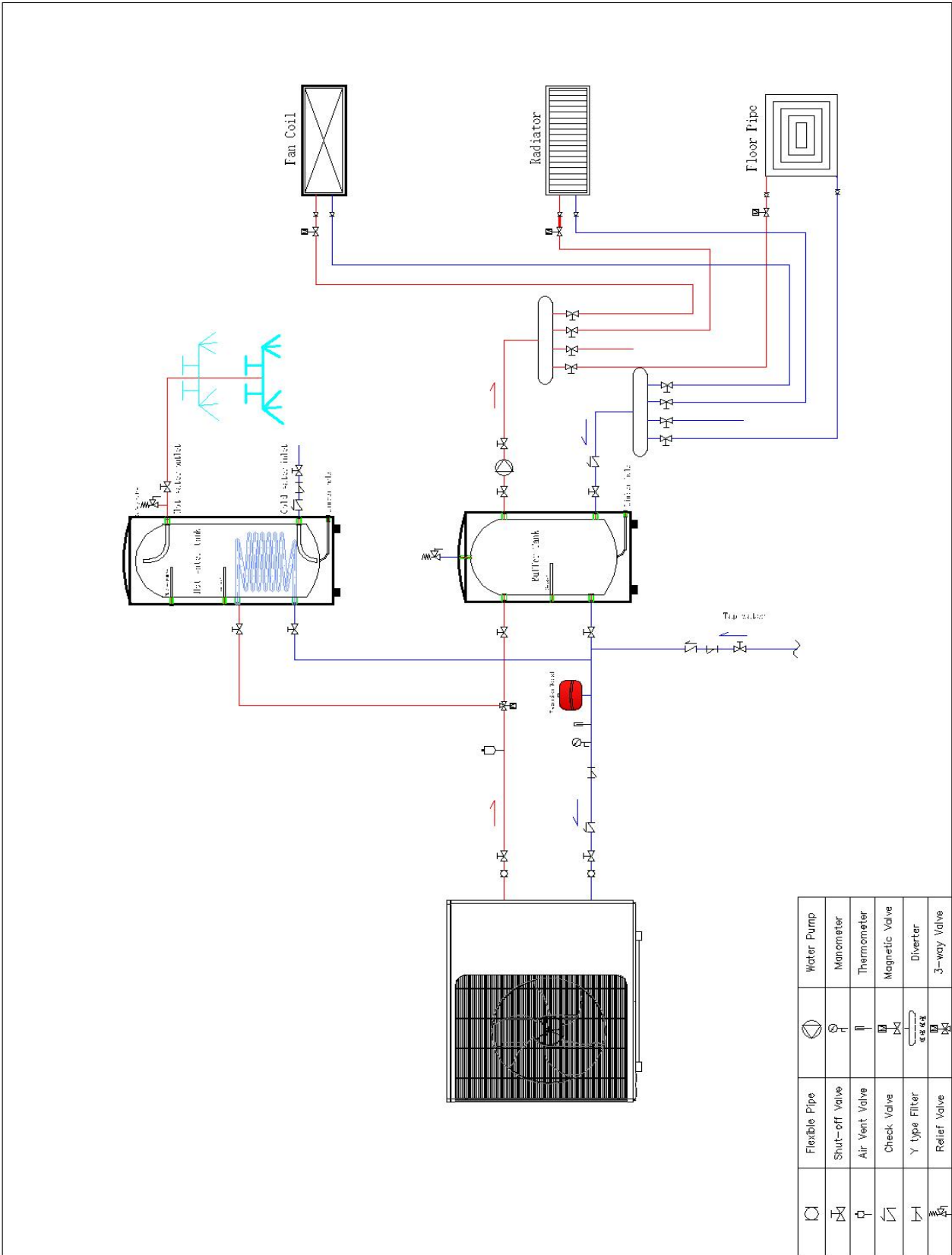

5.1.2. Heating and Cooling (secondary cycle)

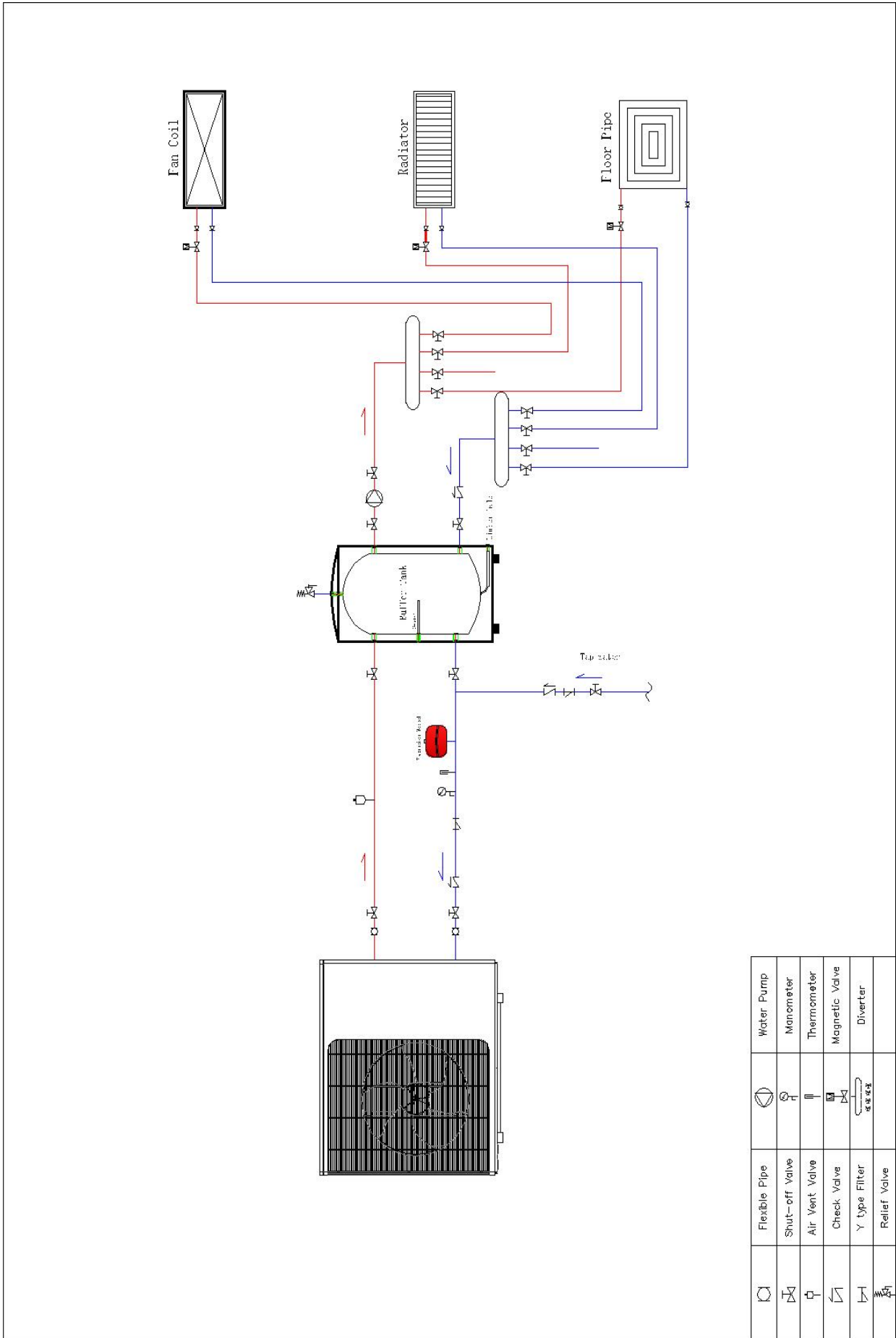

5.1.3. Heating and Cooling (primary cycle)

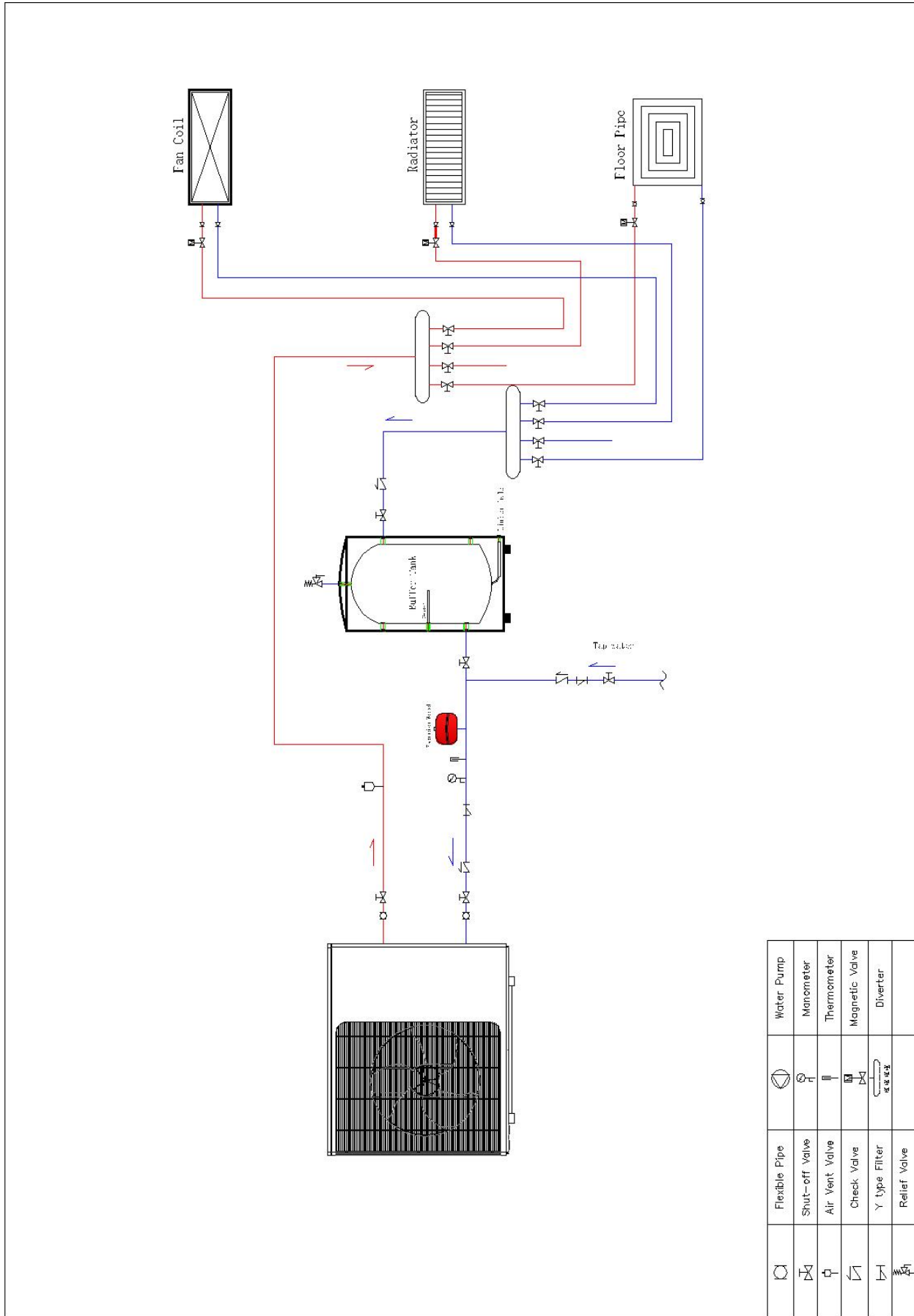

5.2. Materials Required for the Installation

Please read and observe all warning notices and instructions before installing this product. Only the professional and qualified installation service personnel can install the heat pump.

For all heat pump installations, the installer shall prepare the following items:

- ① Pipe fittings.
- ② Concrete base or support above the ground, and take drainage measures.
- ③ Ensure that a suitable power cord is provided, refer to the nameplate on the heat pump for electrical specifications.
- ④ It is recommended to use PP flame retardant corrugated hose sheath.
- ⑤ In the case of low water pressure, use the booster pump to pump water.
- ⑥ Filters need to be installed at the water inlet.
- ⑦ Pipe lines shall be insulated to reduce their heat loss.

Tip: It is recommended to install a stop valve at the inlet and outlet water to facilitate maintenance.

5.2.1. The Required Tools

Halogen detector, explosion-proof vacuum pump, refrigerant meter group, multimeter, electrostatic bracelet, level equipment, pencil, cross screwdriver, impact drill and drill, right angle ruler, measuring tape or ruler, electrical tape, sheep horn hammer, art knife, movable wrench, inner hexagon wrench, pliers, sharp holder, ytterbium guard.



The installation of the products shall be performed by the professional installation personnel or following their instructions.

5.3. Installation Location

- ① Do not install heat pumps near dangerous materials and places.
- ② Do not install the heat pump under a deep sloping roof without a drain, which will mix rainwater with debris and force it through the equipment.
- ③ Place the heat pump on a slightly sloping flat surface, such as a concrete or precast slab. This will properly drain the condensate water and rainwater from the bottom of the equipment. If possible, placed at the same height or slightly higher as the filtration system/equipment.
- ④ The installation position, spacing and ventilation shall comply with the technical requirements of the heat pump manufacturer.
- ⑤ Avoid flammable gas leakage or the environment with strong corrosive gas.
- ⑥ The electrical system and intelligent control components of the system should avoid the filed with direct action of strong current and strong magnetic.

- ⑦ In order to facilitate maintenance and troubleshooting, there are no obstacles within the vertical distance of 2m to facilitate ventilation.
- ⑧ Try to stay away from crowded places, avoid places easy to produce noise and vibration, and take noise reduction measures if necessary.
- ⑨ Should avoid the harsh natural conditions (such as heavy lampblack, large wind and sand, serious lampblack pollution).
- ⑩ The installation position shall be equipped with safety warning signs.
- ⑪ The installation position shall be convenient for the water pipe and the electrical connection.
- ⑫ Fully consider the fire protection, ventilation, drainage requirements, to facilitate maintenance.
- ⑬ With a qualified power supply matching with the equipment to be installed, the power supply shall be dedicated, with sufficient capacity and reliable grounding.
- ⑭ The base or foundation of the installation site shall be strong and have sufficient carrying capacity, with hollow structure or embedded drainage tank. Isolation measures shall be added at the connection between the heat pump and the foundation. The process of isolation measures, usage requirements, noise level and vibration, frequency characteristics, transmission method and noise and vibration shall meet the design requirements.
- ⑮ When the unit is installed on the roof or in the open place, the lightning protection measures should be added.

5.4. Installation Details

5.4.1. General Requirements

- ① Please read the operating instructions before installation, usage and maintenance.
- ② Heat pumps must be installed by professional personnel according to the local electrical wiring specification and this instruction.
- ③ Leak detection test must be performed after installation.
- ④ Do not use any method to accelerate the defrosting process or clean the frosting except as particularly recommended by the manufacturer.
- ⑤ Do not break or ignite the product.
- ⑥ Equipment shall be stored in a room without continuous fire source (e.g. open flame, lit gas stove, open electric heater).
- ⑦ When maintenance is needed, please contact the nearby after-sales service center. The operation manual provided by the manufacturer must be strictly followed. Non-professional maintenance is prohibited.
- ⑧ The storage environment of the equipment should be kept ventilated to avoid direct sunlight.

⑨ Contact the local maintenance center before installation and remove installation. Safety inspection must be conducted before maintaining or repairing the R290 heat pump to ensure that the risk of danger is minimized.

5.4.2. **Open Cabinet and Check**

① The heat pump should be checked in the area with good ventilation (open doors and windows). The ignition source is strictly prohibited.

② Before opening the cabinet, check the refrigerant leakage. If leakage is found, the heat pump should not be installed.

③ The heat pump should be checked for any damage marks and whether the appearance is good.

5.4.3. **Safety Principles for Heat Pump Installation**

① The installation site shall be well ventilated (open doors and windows).

② Fire ignition source in the area with R290 refrigerant is prohibited.

③ When installing the heat pump, anti-static measures should be taken, such as wearing cotton clothing/anti-static clothing, hands with cotton gloves, wearing wireless electrostatic bracelet, etc.

④ The leak detector must be in a working state during the installation process.

⑤ If R290 refrigerant leakage is found during installation, immediately conduct concentration detection on the indoor side environment and open the window/door for ventilation until reaching a safe level. If the performance of the heat pump is affected by the refrigerant leakage, the operation should be stopped immediately, and the heat pump must be transported back to the maintenance station for treatment.

⑥ The installation position of the heat pump shall be easy for installation and maintenance, and no obstacles around the inlet and outlet of the unit, shall not be close to the heat source.

⑦ No installation in a flammable and explosive environment.

⑧ When the heat pump is installed or repaired, when the length of the power line and indoor and outdoor machine connection line is not enough, it must be replaced according to the original specifications, and it is strictly prohibited to connect and extend it.

5.4.4. **Installation Instructions for the Monobloc and Outdoor Units**

All the criteria given in the following sections reflect minimum distance, but each installation must also be evaluated, while considering local general conditions such as wall distance and height and distance from the public access area, the placement of the heat pump must provide distance on all sides for maintenance and inspection.

- ① The heat pump installation area must be well ventilated and shall not hinder the air inlet/air outlet.
- ② The installation area must have a good drainage system and build on a solid foundation.
- ③ Do not install equipment in areas where pollutants such as corrosive gases (chlorine or acid gas), dust, sand and leaves accumulate.
- ④ In order to conduct easier and better maintenance and troubleshooting, the obstacles around the equipment should not be less than 1m. And there is no obstacle within 2m of the vertical direction of the ventilation device. (see Figure 1)

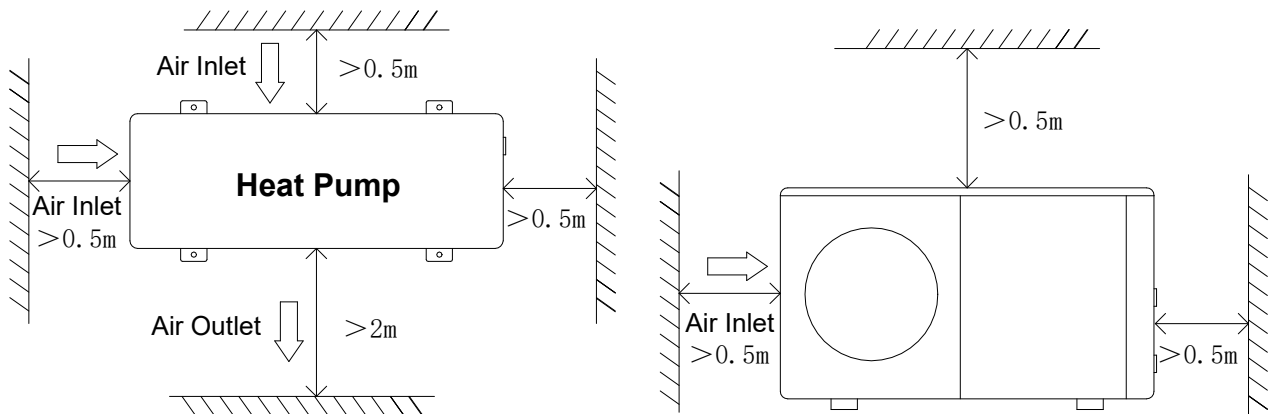

Figure 1

- ⑤ Heat pumps must be fitted with shock-proof bushing to prevent vibration and/or imbalance.
- ⑥ Even if the controller is waterproof, care should be taken to avoid direct sunlight and high temperature. In addition, the controller should be placed near to heat pumps to ensure easier view.
- ⑦ Pipe must be fitted with proper supports to prevent possible damage due to vibration. Tap water pressure shall be kept above 196 kpa. Otherwise, the booster pump should be installed.
- ⑧ The acceptable operating voltage range shall be within $\pm 10\%$ of the rated voltage.
- ⑨ For safety reasons, the heat pump unit must be grounded.

5.5. Accessories



The following attachments are delivered along with the product. Please check promptly and for any missing or damage, contact your local dealer.

Outdoor unit:

Name	Quantity
User's Manual	1
Rubber Pads	4

5.6. Electrical Connection

Before installing the heat pump, ensure that all high-voltage circuits are disconnected. Contact with them may cause death or serious injury to the user, installer, or other person, and possibly property damage.

When repairing the heat pump, mark all wires before disconnecting, the wrong wiring can lead to improper and dangerous operation, check and ensure normal operation after repair.

5.6.1. Power Source

① If the power supply voltage is too low or too high, it may cause damage or unstable operation of the heat pump unit.

② The minimum starting voltage shall be above 90% of the rated voltage, and the acceptable operating voltage range shall be within $\pm 10\%$ of the rated voltage.

③ Ensure that the cable specifications meet the correct requirements for the specific installation, and the distance between the installation site and the main power supply will affect the cable thickness, and select the cables, circuit breakers and isolated circuit breakers according to the local electrical standards.

5.6.2. Grounding and Overcurrent Protection

To prevent electric shock caused by electric leakage, please install the heat pump according to the local electrical standards.

① Do not frequently interrupt the voltage supply of the heat pump, because this may lead to the shortened life expectancy of the heat pump.

② When installing overcurrent protection, ensure the correct current rating for the specific installation.

③ If the heat pump controller needs to control the additional auxiliary heater, the relay (or power supply) of the auxiliary heater must be connected to the relevant output of the controller.

5.6.3. Heat Pump Power Supply Connection

1) Power Supply Wiring of the Single-phase Input

Get a 3-core power cable with the appropriate length conforming to the local safety regulations, connect to the terminal block of the unit.

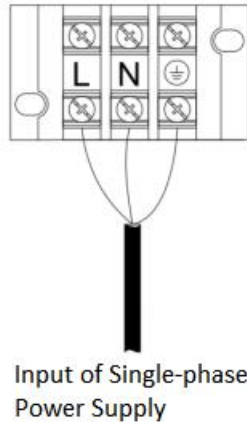

2) Power Supply Wiring of the Three-phase Input

Get a 5-core power cable with the appropriate length conforming to the local safety regulations, connect to the terminal block of the unit.

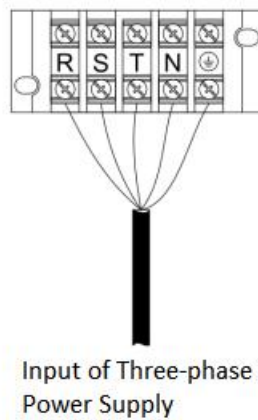

5.6.4. Electric Heating Wiring Connection of the Water Tank

Get a 2-core power cable ($1.0\text{mm}^2 * 2$) with the appropriate length conforming to local safety regulations, where the water tank electric heating line is 220V signal line, electric heating power exceeds 1kW, please connect external suitable relay or contactor.

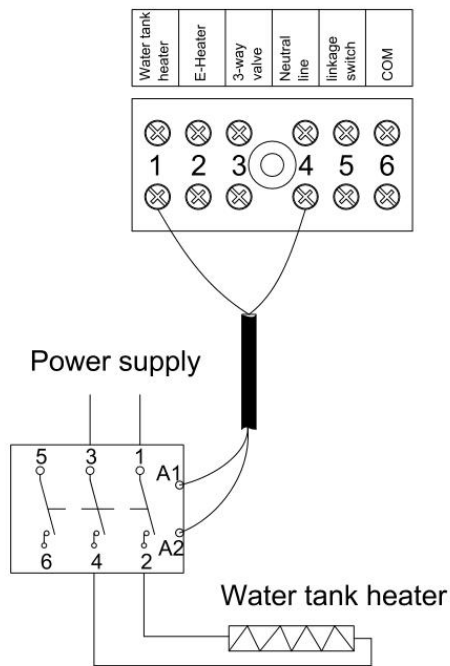

5.6.5. Heating Electric Heating Wiring Connection

Get a 2-core power cable (1.0mm² * 2) with the appropriate length conforming to local safety regulations, where heating electric heating line is 220V signal line, electric heating power exceeds 1kW, please connect external suitable relay or contactor.

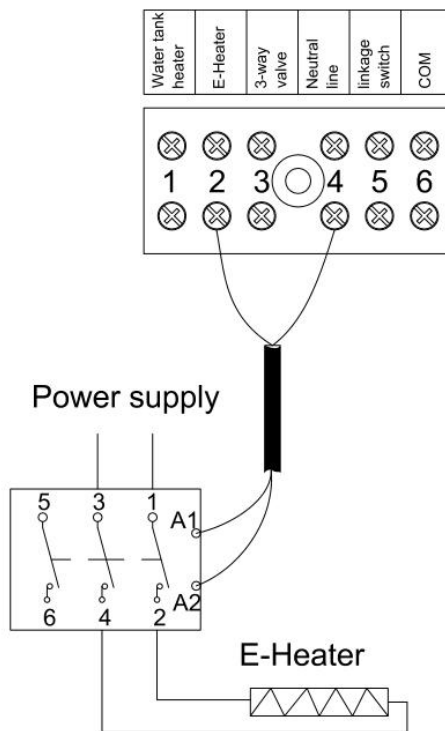

5.6.6. Three-way Valve Wiring Connection

Get a 2-core power cable (1.0mm² * 2) with suitable length in accordance with local safety

regulations.

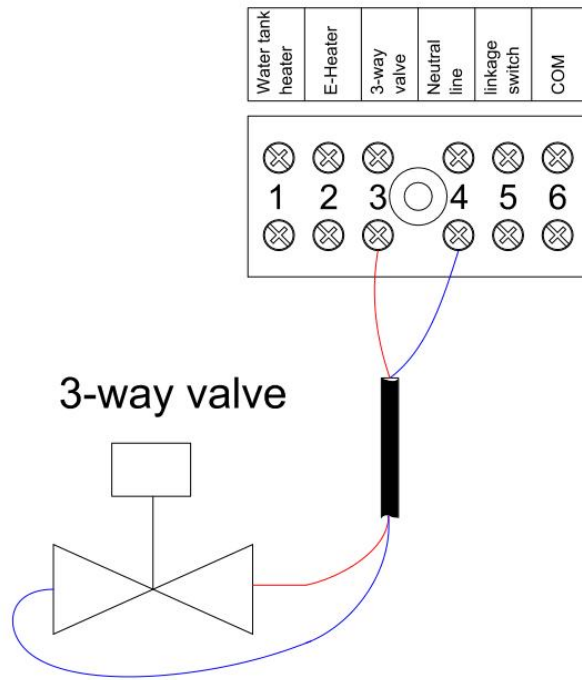

5.6.7. SMART GRID Wiring

Terminal block connecting SG and EVU

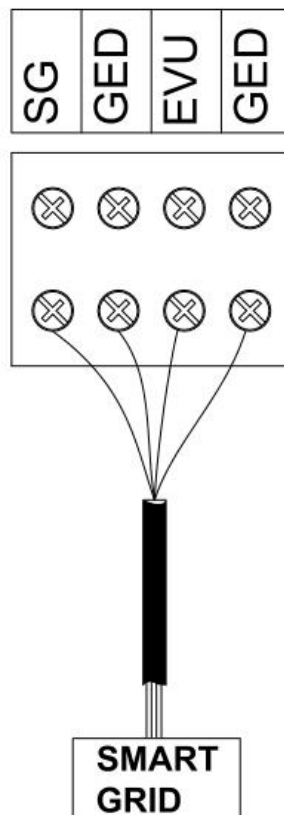

5.6.8. Multiple Units Connected

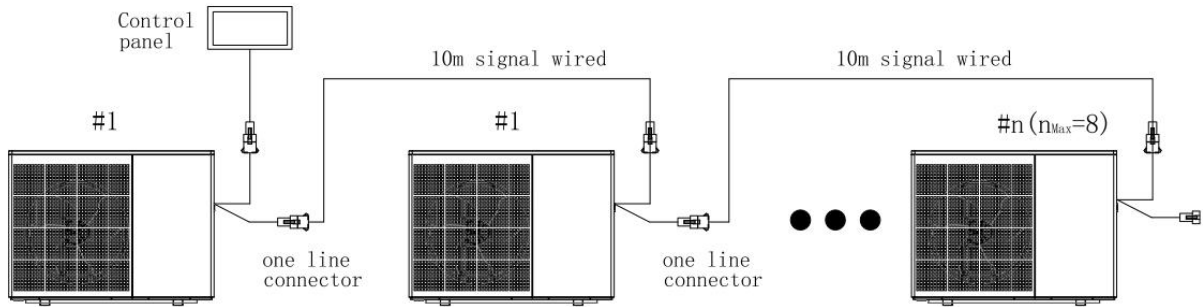

When using cascade function, it is necessary to select the number of cascade units qty on the main PCB board, which can control max. 8 units. The details are as follows:

Unit	SW1-2	SW1-3	SW1-4
#1	OFF	OFF	OFF
#2	OFF	OFF	ON
#3	OFF	ON	OFF
#4	OFF	ON	ON
#5	ON	OFF	OFF
#6	ON	OFF	ON
#7	ON	ON	OFF
#8	ON	ON	OFF

5.7. Water Circulation Connection

- (1) It is recommended to install quick connection fittings at the inlet and outlet junctions.
- (2) Recommend using stainless steel or PPR pipes for heat pump piping. The inlet and outlet connections of the heat pump use stainless steel or PPR fittings.

5.7.1. Pipeline Installation Requirements

- ① When the water pressure exceeds 490 Kpa, please use a pressure reducing valve to reduce the water pressure to below 294 Kpa.
- ② The parts connected to the unit shall be connected by live connection mode, and the intermediate valve shall be installed.
- ③ Ensure that all pipes are properly completed, and then perform water leakage and pressure testing.
- ④ All pipes and fittings must be insulated to prevent heat loss.
- ⑤ Install a drain valve at the lowest point of the system to enable the system to drain under freezing conditions (in winter).

- ⑥ Install the check valve at the outlet connection to prevent the reverse siphon phenomenon when the water pump stops.
- ⑦ To reduce the back pressure, the pipe shall be installed horizontally.
- ⑧ And minimize the elbow (90 degree connection). If higher flow is required, install a bypass valve.

5.8. Transportation

- (1) The handling and lifting plan of the unit shall be prepared in advance, which shall include the unit arrival date, size, weight, handling path, reserved hole position and lifting equipment.
- (2) When lifting the unit, do not be careless, keep a distance, to ensure their own safety, prohibit violent handling.
- (3) When lifting and transporting, the weight of the unit must be considered, and the cloth belt should be supported as a hanger to prevent the damage to the plywood carton, and maintain the horizontal and vertical state as far as possible, and prohibit the tilt of the machine to be more than 30 degrees Angle.
- (4) When lifting and transporting units, the unit shall avoid scratching or deformation, and place protective pads or other supports at the contact parts between the belt and the machine. Refer to the picture below (Figure 1)

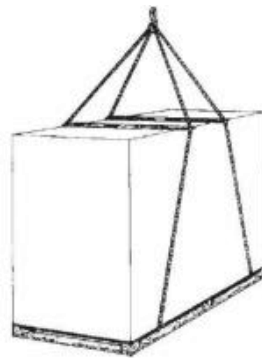

Figure 1

5.9. Trial Run

5.9.1. Notice

- ① Trial operation occurs only after electrical safety inspection.
- ② Do not block the air inlet and outlet, otherwise it may cause the unit performance to decline or start the protection device to operate.
- ③ Ensure all valves are open, flush the water system and ensure the water cleanliness complying with requirements.
- ④ Fill and empty the water system to ensure no air in the water system.

5.9.2. Starting

Use the control panel to control the operation of the machine and check the following items according to the operation instructions.

- ① Whether the control panel on-off is normal.
- ② Whether the control panel function key is normal.
- ③ Whether the parameters are normal.
- ④ Whether the drainage is normal.
- ⑤ Whether the temperature difference between the inlet and outlet water is normal (4~7°C).
- ⑥ Whether the vibration and sound are normal during operation.
- ⑦ Whether the wind, noise and condensate water generated during the operation affect the neighbors.

- ⑧ Any refrigerant leakage.

Note: When the unit is stopped and restarted, the unit has the protection function, and the compressor delays for 3 minutes.

6. Maintenance

With regular effective maintenance and maintenance on the unit, the operation reliability and service life of the unit will be greatly improved.

Pay more attention to the following important tips during maintenance:

- (1) The water filter should be cleaned regularly to ensure the water is clean and avoid damage caused by filter element blockage.
- (2) Users shall not change the internal structure or wiring of the equipment. All safety protection devices have been set up before leaving the factory, and it is strictly prohibited to adjust them by themselves. We shall not assume any responsibility for the equipment damage caused by the user's self-adjustment.
- (3) Shall clean the surface of the surface of the evaporator regularly (every 1-2 months). If the unit operates in a dirty or oily environment, please clean the evaporator with the designated detergent to ensure the performance and efficiency of the unit.
- (4) The water supply of the water system and exhaust device should be frequently checked, to avoid the air entering the system, resulting in the reduction of water circulation, or the failure of water circulation, which affects the cooling, heating efficiency and working reliability of the unit.
- (5) The intelligent control system can automatically analyze various protection problems in daily use and display the fault code on the controller. The unit can recover by itself. In normal operation, the pipes in the unit does not require any maintenance.
- (6) Check the power supply and electrical wiring frequently to ensure that the wiring is firm and

the electrical components are normal. If abnormal, it should be repaired or replaced, and the unit should be reliably grounded.

- (7) Check each components during operation. Check whether the working pressure of the cooling system is normal. Check the pipe joint and the air injection valve for grease stains. Ensure that there is no refrigerant leakage in the cooling system.
- (8) Check whether the installation is firm, do not pile up any debris around the equipment, to prevent the blockage of the air inlet and air outlet. The unit shall be kept clean, dry and ventilated.
- (9) When the unit needs a long rest after a period of operation, the water in the water system should be removed. And turn off the power and cover the equipment. When the water system is filled with water and fully check the unit, start up preheating for at least 6 hours. Affirm that everything is normal, and then starting up again.
- (10) No special repair or maintenance of the water systems in the unit unless the water pump is damaged. It is recommended to clean the water filter regularly, or to replace it when it is very dirty or blocked.

Notice:

- (1) The unit shall be equipped with a special power supply. The voltage range shall be within $\pm 10\%$. The switch shall be automatic air switches. The setting current shall be 1.5 times of the operating current and shall have lack phase protection. Knife gate cannot be used in the unit.
- (2) Before not running for a long time, the equipment must be powered up for at least 12 hours. If the single cooling model does not work for a long time in winter, we must drain all the water to prevent the pipeline and the unit from freezing. The controller and the unit should be kept corresponding. In winter, the single heating models should not be powered off when they are stopped for a long time to avoid freezing damage.
- (3) The heat pump on-off can not be operated frequently, not more than 4 times within an hour. Electrical cabinet shall be protected from damp.
- (4) It is forbidden to flush the FULL DC INVERTER air source heat pump with water to avoid accidents such as electric shock.
- (5) The user shall not change the structure or wiring inside the equipment.
- (6) Service and maintenance shall be performed by the qualified and well-trained technical personnel. When the unit operation fails, please cut off the power supply immediately.
- (7) The intelligent control system can automatically analyze various protection problems in daily use, and display the error code on the controller. The unit can recover by itself. Under normal operation, the pipeline in the unit does not need any maintenance.
- (8) Under normal environmental conditions, the user cleans the evaporator surface monthly or quarterly.

- (9) If the unit is operating in a dirty or oily environment, please clean the evaporator with the designated detergent to ensure the performance and efficiency of the unit.
- (10) Please pay attention to the surrounding environment, check whether the unit installation is firm, or whether the inlet and outlet of the outdoor unit are blocked.
- (11) No special repair or maintenance of the water systems in the unit unless the water pump is damaged. It is recommended to clean the water filter regularly, or to replace it when it is very dirty or blocked.
- (12) If the unit is not used for a long time in winter, please drain all the water in the system to prevent the water pipe from freezing and damage.

6.1. Cleaning of the Water Filter

The water filter shall be cleaned according to the manual of the water filter to ensure the smooth flow of the water filter system. It is recommended to wash it once in the first month, and then once every six months.

6.2. Cleaning of the Plate Heat Exchanger

Because very high turbulence is usually present in the heat exchanger, the self-cleaning effect exists in the channel. However, in some applications, pollution can be very high, such as when the water quality is extremely hard at high temperatures. In this case, the heat exchanger can be cleaned by pumping the circulating cleaning fluid (5% oxalic acid). This work should be done by qualified people. For further information, please contact your supplier.

6.3. The Refrigerant Charge

Refrigerant plays an important role in the cooling or heating process, and the insufficient refrigerant will directly affect the effect of cooling or heating. Before adding the refrigerant, note the following:

- The work shall be done by a professional person.
- If there is insufficient refrigerant inside the system, check the system for leakage. If any, please repair before charging refrigerant, otherwise the unit will lack refrigerant again after a short time.
- Do not add too much refrigerant, or it may cause other faults such as high pressure and poor performance.
- The system uses R290 refrigerant. It is strictly prohibited to charge the refrigerant other than R290 into the system.
- There must be no air in the refrigerant system, because the air can cause abnormal high pressure, which can damage the gas pipe and affect the cooling or heating effect.
- If the refrigerant leaks inside the house, please keep the window open for a few minutes, evacuate the persons at the site, and evacuate the refrigerant naturally.

Note: Always use a weight scale to measure the amount of refrigerant charging the unit.

6.4. Cleaning of the Evaporator

The condensers do not require any special maintenance unless they are blocked, clean by using a low pressure rinse with detergent and clean water, then rinse with clean water:

Make sure the equipment is powered off before cleaning.

The unit interior must be cleaned by professional personnel.

Do not use gasoline, benzene, detergent and other cleaning devices. And do not spray pesticides. Otherwise, it may damage the equipment. Special detergent is recommended for 5-8 minutes.

Then spray the fins with clean water.

The old brush can brush with dirt and fins on the surface. The brush grooves between the fins are in the same direction, so the bristles move between the fins. After cleaning, clean the unit with a soft dry cloth.

6.5. Maintenance of the Outdoor Unit

6.5.1. Controller Maintenance

Cut off the power supply, remove the top cover of the unit, and remove the cover of electrical compartment. Carry out the necessary maintenance on the controller and electrical components of the heat pump.

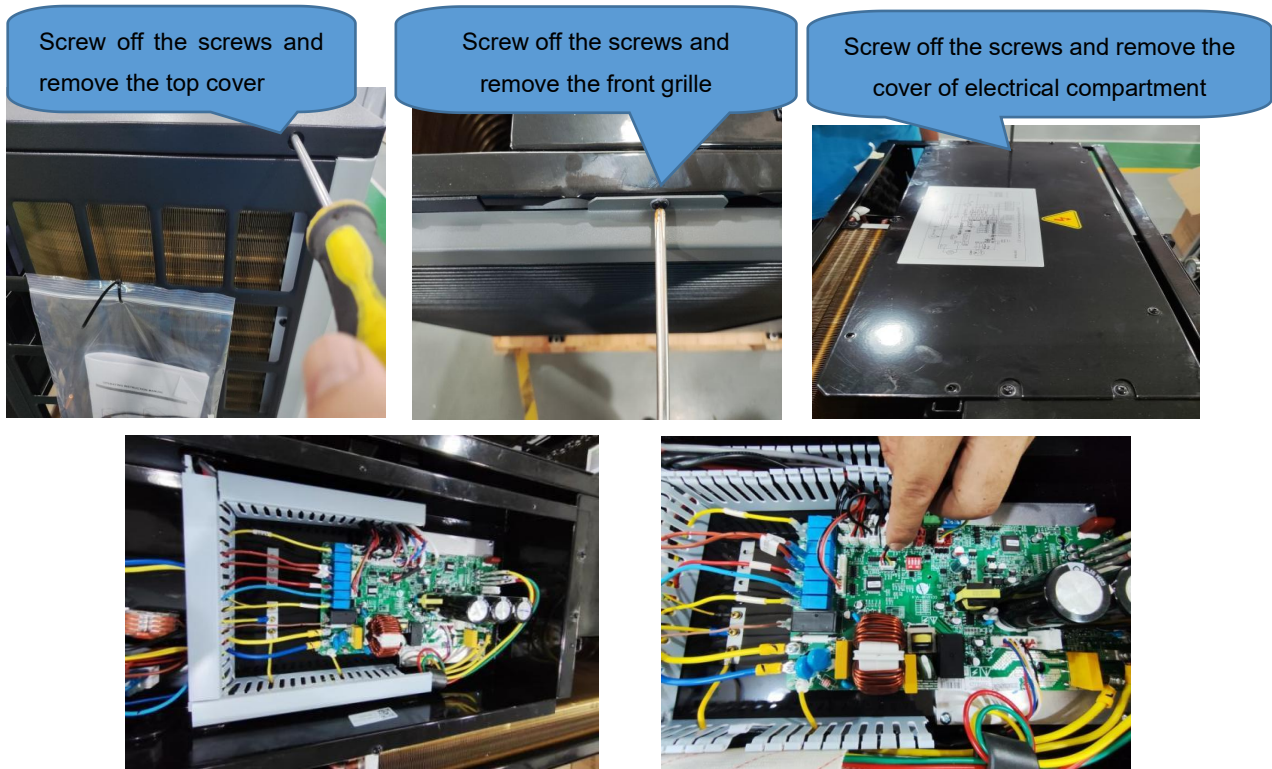

6.5.2. Replace the Water Pump

Cut off the power supply, open the front panel, and remove the cover of electrical compartment. Disconnect the quick connector of the water pump power cable and remove the signal cable connected to the main PCB.

Cut off the water supply to the unit and drain the water from the unit. Release the joint of the water pump with a wrench and remove the water pump from the unit.

Connect a new water pump back to the unit's water system and electrical system.

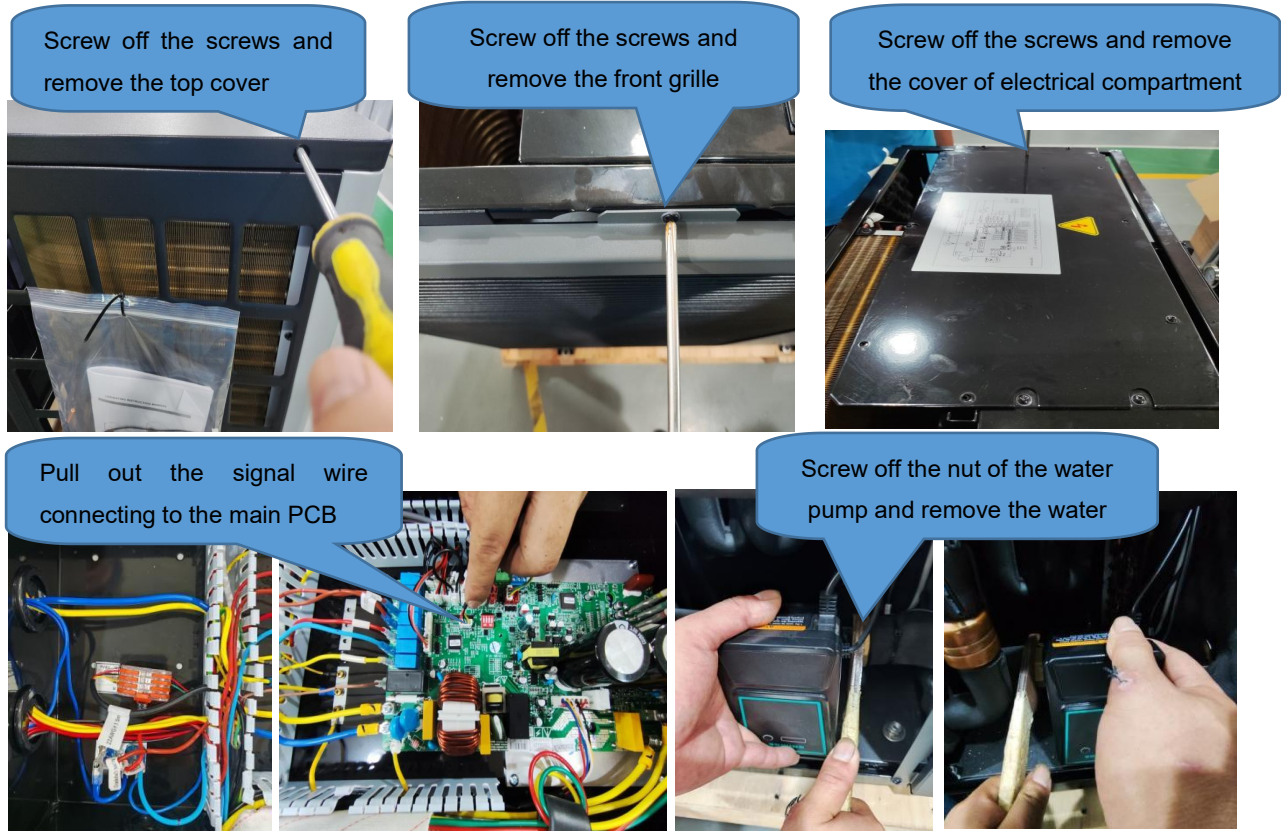

6.5.3. Replace Fan Blades and Fan Motor

Cut off the power supply and remove the screws from the front grille.

Screw off the nut from the fan blade with a wrench and remove the fan blades.

Remove the screws for the fan motor.

Pull out the power cable of the fan motor from the main PCB.

Put the repaired or new fan motor back, and connect all cables.

Screw off the screws and remove the top cover

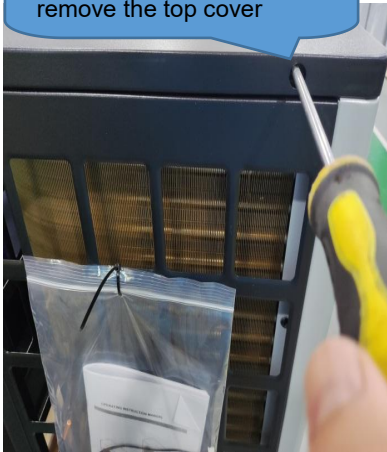

Screw off the screws and remove the front grille



Screw off the screws and remove the cover of electrical compartment



Pull out the signal line of fan motor from main PCB

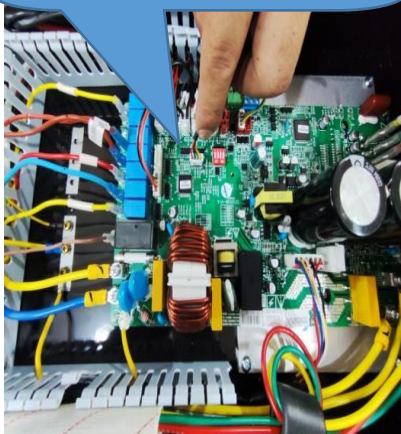

Screw off the nut and remove the fan blades

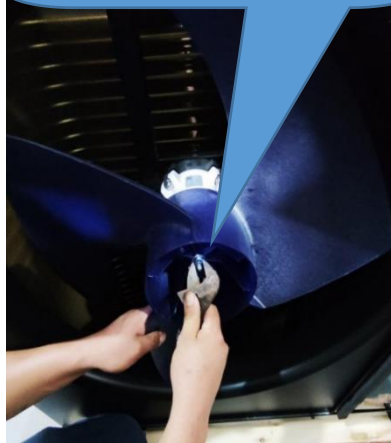

Screw off the screws and remove the fan motor

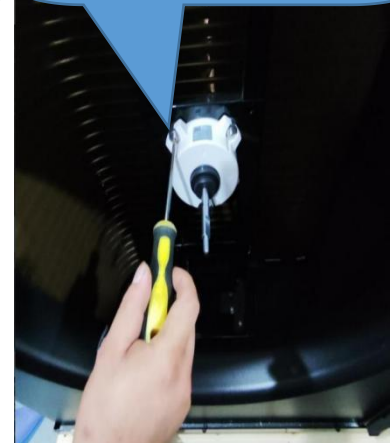

7. Electrical Wiring Diagram

PW030-DKZLRS-E/S PW040-DKZLRS-E/S

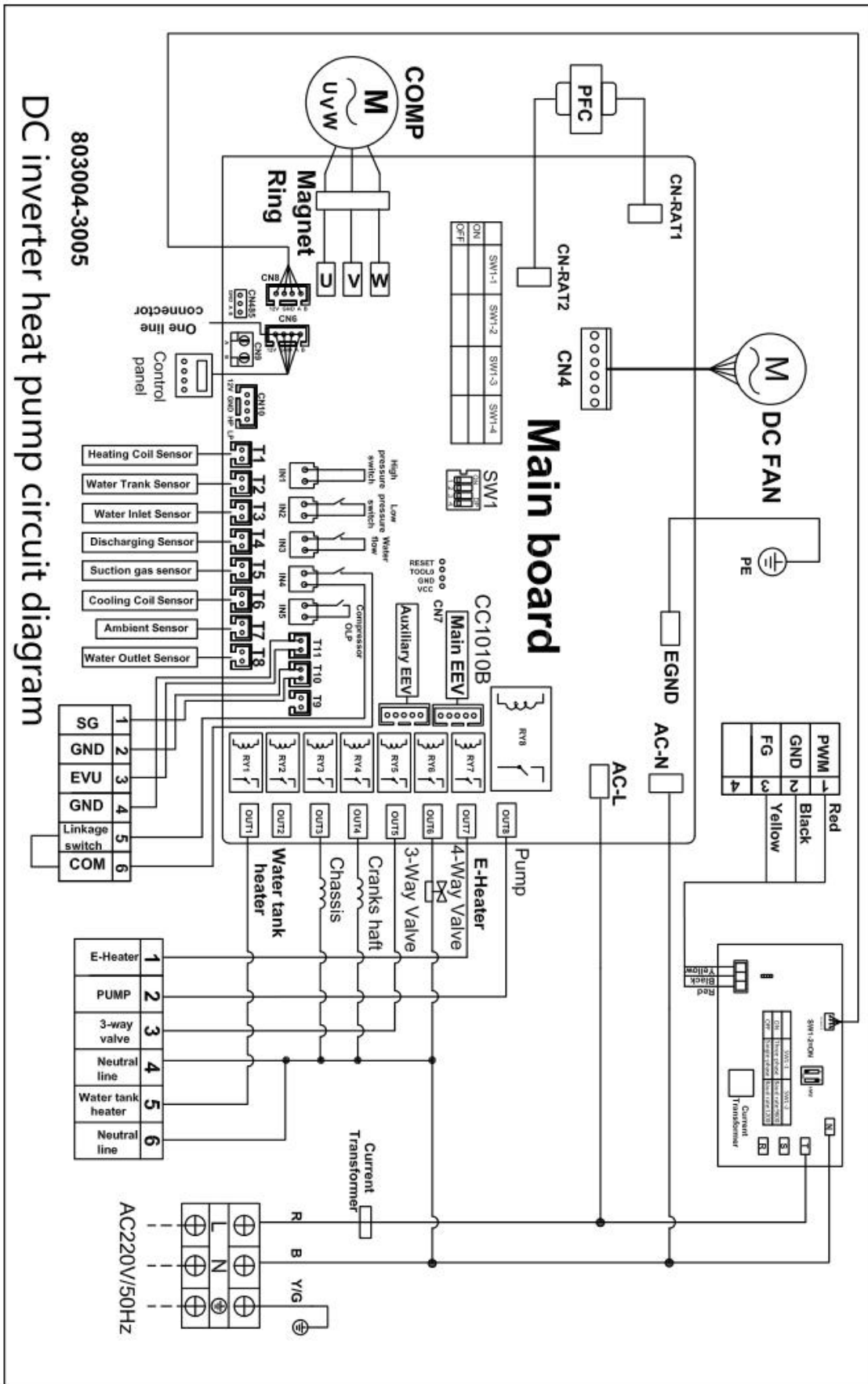

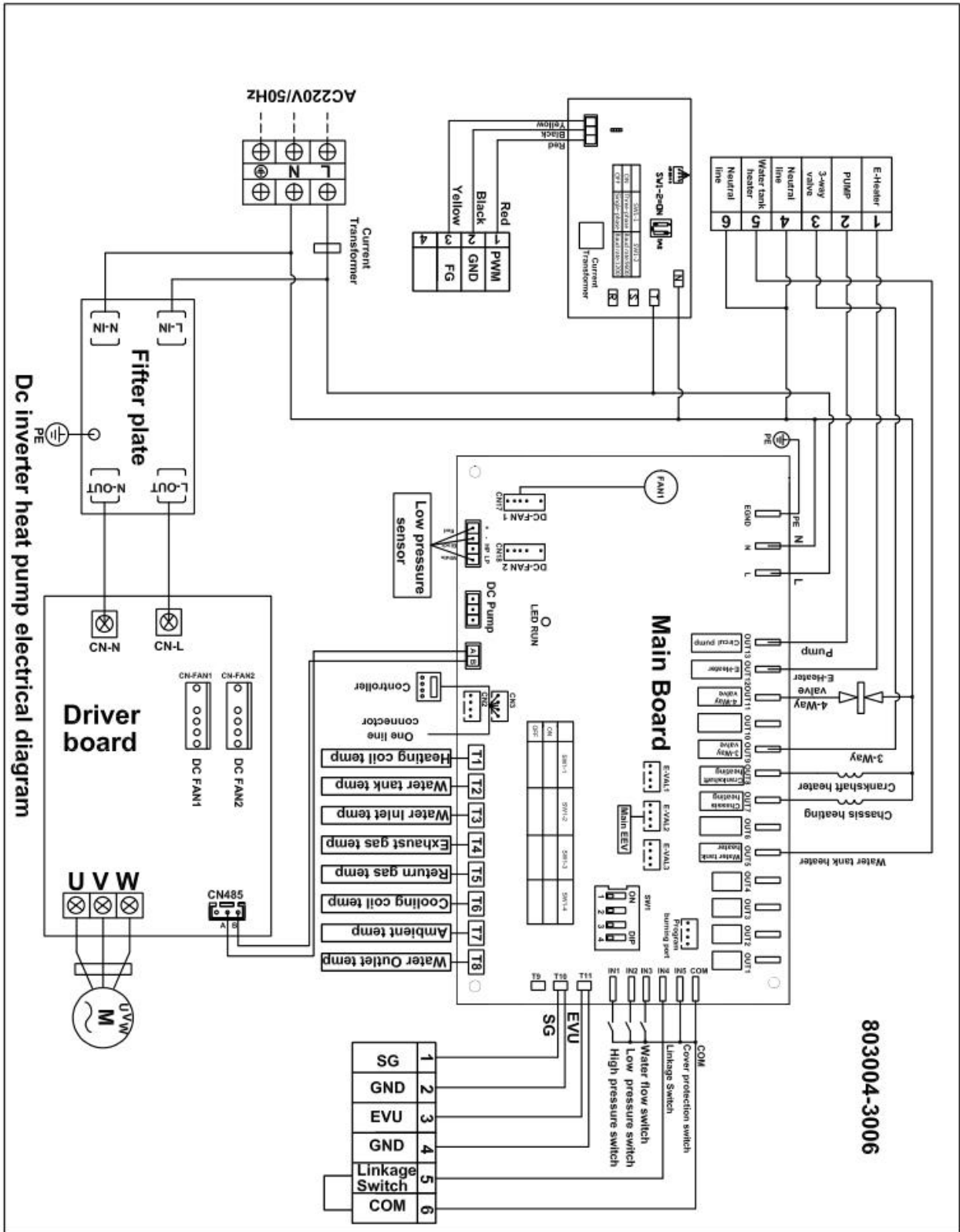

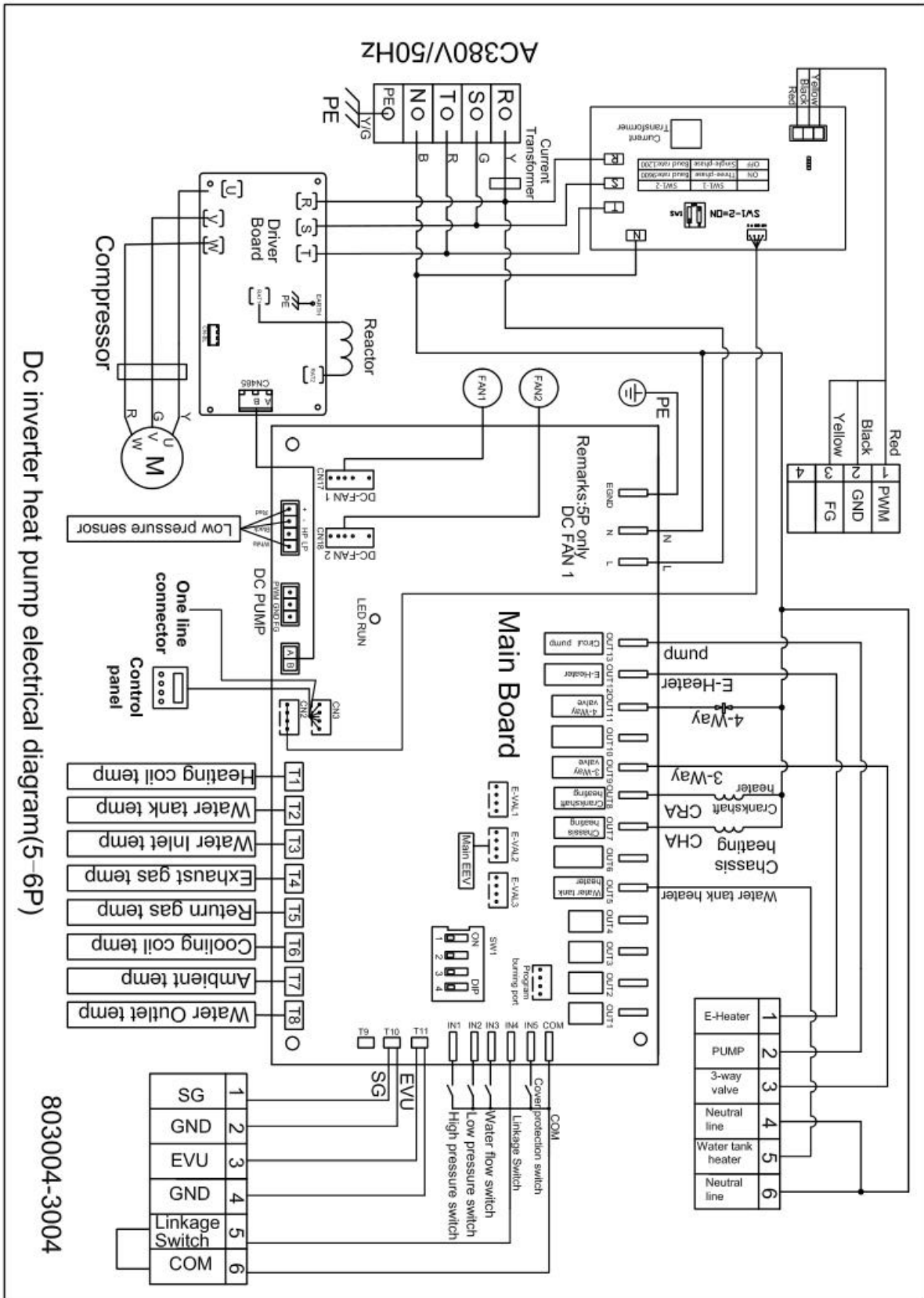

Dc inverter heat pump electrical diagram(5-6P)

803004-3004

8. Technical Parameters

Technical data				
Model		PW030-DKZLRS-E/S	PW040-DKZLRS-E/S	PW050-DKZLRS-E/S
Heating Condition - Ambient Temp.(DB/WB): 7/6℃, Water Temp.(In/Out): 30/35℃				
Heating Capacity Range (kW)		3.3~8.3	4.5~11.4	5.9~14.8
Heating Power Input Range(kW)		0.64~2.18	0.85~2.95	1.13~3.83
COP Range		3.81~5.17	3.86~5.29	3.86~5.22
DHW Condition-Ambient Temp.(DB/WB): 7/6℃, Water Temp.(In/Out): 15/55℃				
Heating Capacity Range (kW)		3.7~7.4	5.2~10.2	6.6~13.2
Heating Power Input Range(kW)		0.79~2.10	1.10~2.87	1.41~3.73
COP Range		3.52~4.69	3.55~4.71	3.54~4.67
Heated Water Output (L/H)		159	219	283
Cooling Condition - Ambient Temp.(DB/WB):35/24℃, Water Temp.(In/Out): 12/7℃				
Cooling Capacity Range (kW)		2.4~5.8	3.3~8.2	4.3~10.8
Cooling Power Input Range(kW)		0.79~2.19	1.08~3.07	1.39~3.99
EER Range		2.65~3.04	2.67~3.06	2.71~3.10
Space Heating (According to EN14825:2022) Average Climate Water Outlet 35℃	ErP Level	A+++	A+++	A+++
	Sound pressure level (dB(A)) at 1 meter	44	43	45
	Sound power level (dB(A))	58	57	59
Space Heating (According to EN14825:2022) Average Climate Water Outlet 55℃	ErP Level	A++	A++	A++
	Sound pressure level (dB(A)) at 1 meter	44	47	46
	Sound power level (dB(A))	58	61	60
Refrigerant		R290		
Moisture Resistance		IPX4		
Electrical Shockproof		I		
Power supply		230V/1Ph/50Hz/60Hz		
Max. power input(kW)		3.1	4.1	5.2
Max. current (A)		14.2	18.8	23.8
Fuse or circuit breaker (A)		20	25	32
Diameter of pipe (mm)		DN25	DN25	DN25
Water Flow(m ³ /h)		1.43	1.96	2.55
Water Pressure Drop (max) kPa		30	35	40
Max water head(m)		9	9	9
Net Weight (kg)		112	120	138
Net Dimension (L/W/H) mm		1080×460×820	1080×460×960	1080×480×1060
Operation Ambient Temp.		-25~43℃		
Operating water temperature (℃)		20~65℃(DHW)		
Operating water temperature (℃)		20~70℃(Heating)		
Operating water temperature (℃)		7~35℃(Cooling)		

Technical data			
Model	PW050-DKZLRS-E	PW060-DKZLRS-E	
Heating Condition - Ambient Temp.(DB/WB): 7/6℃, Water Temp.(In/Out): 30/35℃			
Heating Capacity Range (kW)	5.9~14.8	8.8~22.0	
Heating Power Input Range(kW)	1.13~3.83	1.68~5.77	
COP Range	3.86~5.22	3.81~5.24	
DHW Condition-Ambient Temp.(DB/WB): 7/6℃, Water Temp.(In/Out): 15/55℃			
Heating Capacity Range (kW)	6.6~13.2	7.8~17.6	
Heating Power Input Range(kW)	1.41~3.73	1.67~5.01	
COP Range	3.54~4.67	3.51~4.66	
Heated Water Output (L/H)	283	377	
Cooling Condition - Ambient Temp.(DB/WB):35/24℃, Water Temp.(In/Out): 12/7℃			
Cooling Capacity Range (kW)	4.3~10.8	6.2~15.3	
Cooling Power Input Range(kW)	1.39~3.99	1.99~5.60	
EER Range	2.71~3.10	2.73~3.12	
Space Heating (According to EN14825:2022) Average Climate Water Outlet 35℃	ErP Level	A+++	A+++
	Sound pressure level (dB(A)) at 1 meter	44	45
	Sound power level (dB(A))	59	60
Space Heating (According to EN14825:2022) Average Climate Water Outlet 55℃	ErP Level	A++	A++
	Sound pressure level (dB(A)) at 1 meter	45	46
	Sound power level (dB(A))	59	62
Refrigerant	R290		
Moisture Resistance	IPX4		
Electrical Shockproof	I		
Power supply	380V/3Ph/50-60Hz		
Max. power input(kW)	5.2	7.6	
Max. current (A)	9.8	14.3	
Fuse or circuit breaker (A)	16	20	
Diameter of pipe (mm)	DN25	DN25	
Water Flow(m³/h)	2.55	3.78	
Water Pressure Drop (max) kPa	40	45	
Max water head(m)	9	12	
Net Weight (kg)	138	170	
Net Dimension (L/W/H) mm	1080×480×1060	1080×480×1372	
Operation Ambient Temp.	-25~43℃		
Operating water temperature (℃)	20~65℃(DHW)		
Operating water temperature (℃)	20~70℃(Heating)		
Operating water temperature (℃)	7~35℃(Cooling)		

Note:

The above design and specifications are subject to change without prior notice for product improvement.

Detailed specifications of the units please refer to nameplate on the units

9. Performance Curves

PW030-DKZLRS-E/S For heating																		
Ambient temp.(°C)			-25	-20	-15	-12	-10	-7	-5	0	2	5	7	10	12	15	21	
Water temp. outlet35°C	MAX	Heating Capacity(kW)	3.3	4.2	5.0	5.5	5.9	6.4	6.8	7.7	7.9	8.5	8.9	9.2	9.3	9.5	9.8	
		Input power (kW)	1.96	1.99	2.03	2.05	2.07	2.08	2.09	2.11	2.11	2.12	2.13	2.14	2.14	2.10	2.05	1.94
		COP	1.70	2.10	2.45	2.68	2.84	3.08	3.24	3.63	3.75	4.01	4.18	4.31	4.44	4.65	4.65	5.04
	MIN	Heating Capacity(kW)	1.7	2.0	2.2	2.4	2.5	2.7	2.8	3.1	3.2	3.5	3.6	3.7	3.8	3.8	3.9	4.0
		Input power (kW)	0.63	0.64	0.65	0.66	0.66	0.66	0.67	0.67	0.67	0.67	0.68	0.68	0.68	0.67	0.65	0.62
		COP	2.69	3.07	3.44	3.63	3.82	4.10	4.25	4.64	4.79	5.11	5.29	5.46	5.63	5.89	5.89	6.39
Water temp. outlet45°C	MAX	Heating Capacity(kW)	3.2	4.0	4.8	5.3	5.7	6.2	6.5	7.4	7.7	8.2	8.6	8.9	9.0	9.2	9.4	
		Input power (kW)	2.21	2.25	2.29	2.32	2.33	2.35	2.36	2.38	2.39	2.39	2.41	2.42	2.42	2.38	2.32	2.19
		COP	1.43	1.79	2.09	2.29	2.42	2.63	2.77	3.10	3.20	3.43	3.57	3.68	3.79	3.97	3.97	4.31
	MIN	Heating Capacity(kW)	1.6	1.9	2.2	2.3	2.4	2.6	2.7	3.0	3.1	3.3	3.5	3.6	3.6	3.6	3.7	3.8
		Input power (kW)	0.71	0.72	0.74	0.75	0.75	0.76	0.76	0.77	0.77	0.77	0.78	0.78	0.78	0.77	0.75	0.71
		COP	2.28	2.60	2.91	3.07	3.23	3.47	3.60	3.93	4.05	4.32	4.48	4.62	4.76	4.99	4.99	5.41
Water temp. outlet55°C	MAX	Heating Capacity(kW)	2.9	3.7	4.4	4.8	5.2	5.6	6.0	6.7	7.0	7.5	7.8	8.1	8.2	8.4	8.6	
		Input power (kW)	2.43	2.47	2.51	2.55	2.56	2.58	2.59	2.61	2.62	2.63	2.64	2.66	2.66	2.61	2.54	2.40
		COP	1.21	1.49	1.74	1.90	2.01	2.19	2.30	2.58	2.66	2.85	2.97	3.06	3.15	3.30	3.30	3.58
	MIN	Heating Capacity(kW)	1.5	1.7	2.0	2.1	2.2	2.4	2.5	2.7	2.8	3.0	3.2	3.3	3.3	3.4	3.4	3.5
		Input power (kW)	0.78	0.79	0.81	0.82	0.82	0.83	0.83	0.84	0.84	0.85	0.85	0.86	0.86	0.84	0.82	0.77
		COP	1.89	2.16	2.42	2.55	2.69	2.89	2.99	3.27	3.37	3.60	3.73	3.84	3.96	4.15	4.15	4.50
Water temp. outlet60°C	MAX	Heating Capacity(kW)	2.7	3.4	4.0	4.5	4.8	5.2	5.5	6.2	6.4	6.9	7.2	7.5	7.6	7.7	7.9	
		Input power (kW)	2.58	2.62	2.67	2.70	2.72	2.73	2.74	2.77	2.78	2.79	2.80	2.82	2.77	2.69	2.55	
		COP	1.05	1.29	1.51	1.65	1.75	1.90	2.00	2.24	2.31	2.47	2.57	2.65	2.74	2.86	3.11	
	MIN	Heating Capacity(kW)	1.4	1.6	1.8	1.9	2.0	2.2	2.3	2.5	2.6	2.8	2.9	3.0	3.1	3.1	3.2	

		Input power (kW)	0.83	0.84	0.85	0.87	0.87	0.88	0.88	0.89	0.89	0.89	0.90	0.90	0.89	0.86	0.82
		COP	1.65	1.89	2.11	2.23	2.34	2.52	2.61	2.85	2.94	3.13	3.25	3.35	3.45	3.61	3.92
Water temp. outlet65℃	MAX	Heating Capacity(kW)	/	3.1	3.7	4.1	4.4	4.8	5.1	5.7	5.9	6.4	6.7	6.9	7.0	7.1	7.3
		Input power (kW)	/	2.75	2.80	2.83	2.85	2.87	2.88	2.91	2.92	2.92	2.94	2.96	2.90	2.83	2.67
		COP	/	1.14	1.33	1.46	1.54	1.67	1.76	1.97	2.04	2.18	2.27	2.34	2.41	2.53	2.74
	MIN	Heating Capacity(kW)	/	1.5	1.7	1.8	1.9	2.0	2.1	2.3	2.4	2.6	2.7	2.8	2.8	2.9	3.0
		Input power (kW)	/	0.89	0.91	0.92	0.92	0.93	0.93	0.94	0.94	0.95	0.95	0.96	0.94	0.92	0.87
		COP	/	1.65	1.84	1.94	2.05	2.20	2.28	2.49	2.56	2.74	2.84	2.92	3.01	3.16	3.42
Water temp. outlet70℃	MAX	Heating Capacity(kW)	/	/	3.4	3.8	4.0	4.4	4.7	5.3	5.5	5.9	6.1	6.4	6.4	6.6	6.7
		Input power (kW)	/	/	2.87	2.91	2.92	2.94	2.95	2.98	2.99	3.00	3.01	3.03	2.98	2.90	2.74
		COP	/	/	1.19	1.31	1.38	1.50	1.58	1.77	1.83	1.96	2.04	2.10	2.17	2.27	2.46
	MIN	Heating Capacity(kW)	/	/	1.5	1.6	1.7	1.9	2.0	2.2	2.2	2.4	2.5	2.6	2.6	2.7	2.7
		Input power (kW)	/	/	0.92	0.93	0.94	0.94	0.95	0.96	0.96	0.96	0.97	0.97	0.96	0.93	0.88
		COP	/	/	1.67	1.76	1.85	1.99	2.06	2.25	2.32	2.47	2.56	2.64	2.72	2.85	3.09
Water temp. outlet75℃	MAX	Heating Capacity(kW)	/	/	/	/	/	4.0	4.3	4.8	5.0	5.4	5.6	5.8	5.9	6.0	6.2
		Input power (kW)	/	/	/	/	/	3.01	3.03	3.06	3.06	3.07	3.09	3.11	3.05	2.97	2.81
		COP	/	/	/	/	/	1.34	1.41	1.58	1.63	1.74	1.82	1.87	1.93	2.02	2.19
	MIN	Heating Capacity(kW)	/	/	/	/	/	1.7	1.8	2.0	2.0	2.2	2.3	2.4	2.4	2.4	2.5
		Input power (kW)	/	/	/	/	/	0.96	0.97	0.98	0.98	0.98	0.99	0.99	0.97	0.95	0.90
		COP	/	/	/	/	/	1.78	1.85	2.02	2.08	2.22	2.30	2.37	2.44	2.56	2.78
Ambient temp.(℃)			-25	-20	-15	-12	-10	-7	-5	0	2	5	7	10	12	15	21

Curve of Heating Capacity Performance

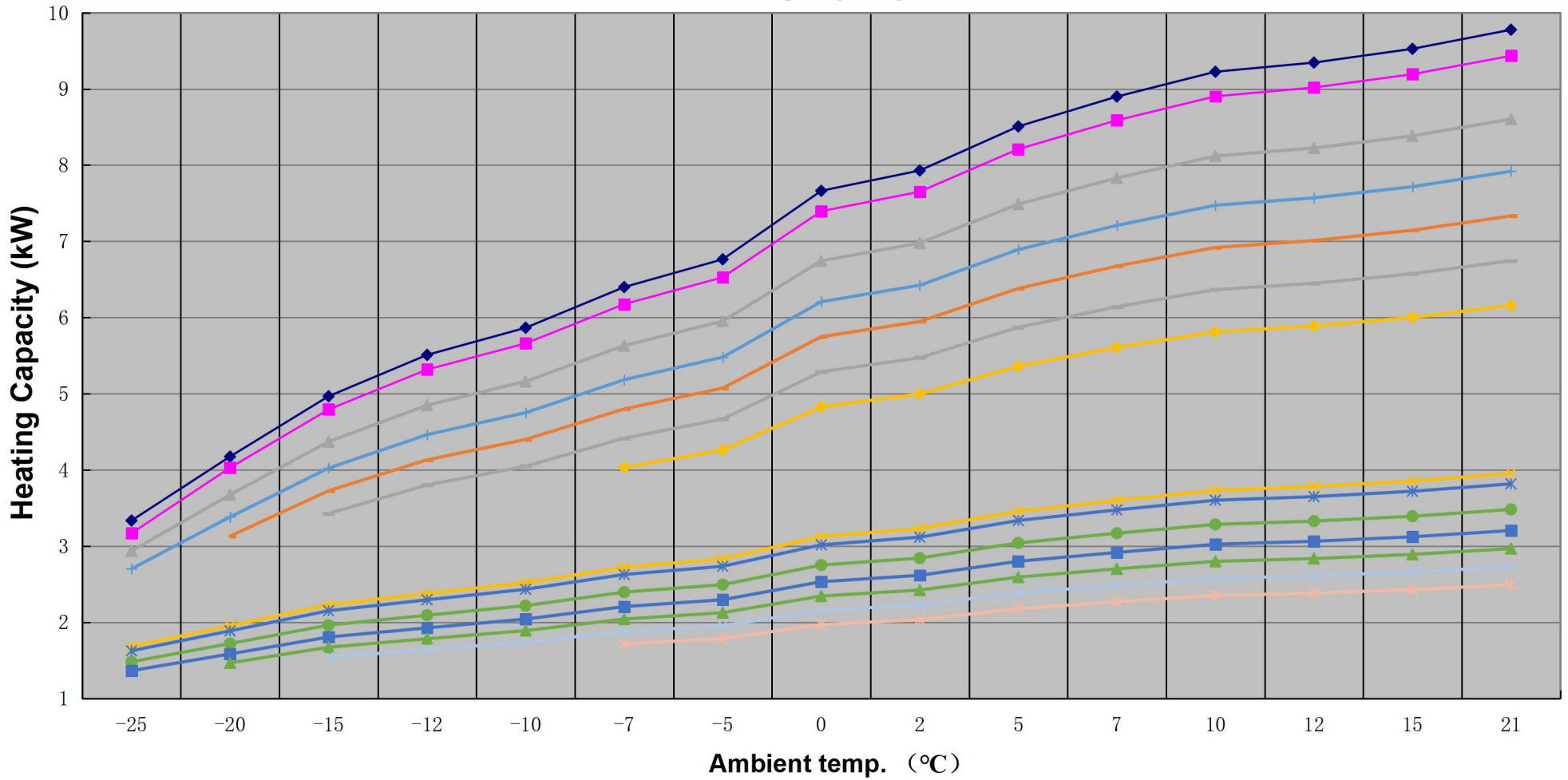

Curve of COP Performance

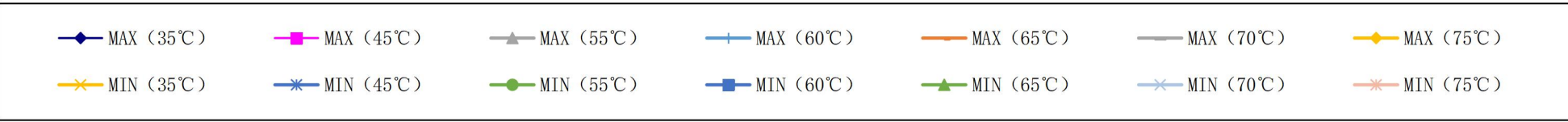
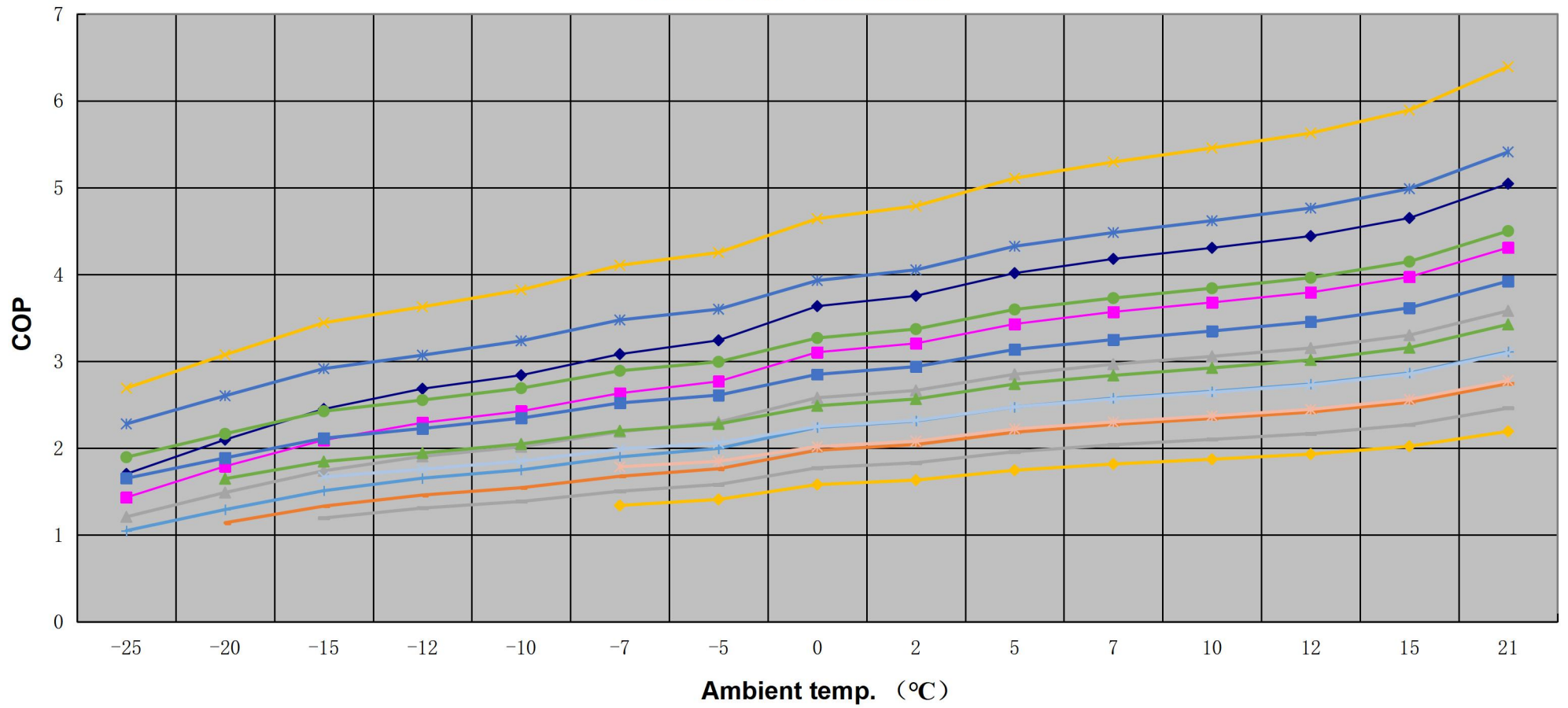

PW040-DKZLRS-E/S For heating

Ambient temp.(°C)		-25	-20	-15	-12	-10	-7	-5	0	2	5	7	10	12	15	21	
Water temp. outlet35°C	MAX	Heating Capacity(kW)	4.3	5.3	6.4	7.1	7.5	8.2	8.7	9.8	10.2	10.9	11.4	11.8	12.0	12.2	12.5
		Input power (kW)	2.54	2.58	2.63	2.66	2.68	2.69	2.70	2.73	2.74	2.75	2.76	2.78	2.73	2.66	2.51
		COP	1.68	2.07	2.42	2.65	2.81	3.05	3.20	3.59	3.71	3.97	4.13	4.26	4.39	4.60	4.99
	MIN	Heating Capacity(kW)	2.1	2.4	2.8	3.0	3.2	3.4	3.5	3.9	4.0	4.3	4.5	4.7	4.7	4.8	4.9
		Input power (kW)	0.78	0.79	0.81	0.82	0.82	0.83	0.83	0.84	0.84	0.85	0.85	0.86	0.84	0.82	0.77
		COP	2.69	3.07	3.44	3.63	3.82	4.10	4.25	4.64	4.79	5.11	5.29	5.46	5.63	5.89	6.39
Water temp. outlet45°C	MAX	Heating Capacity(kW)	4.1	5.2	6.1	6.8	7.2	7.9	8.4	9.5	9.8	10.5	11.0	11.4	11.6	11.8	12.1
		Input power (kW)	2.87	2.92	2.97	3.01	3.03	3.04	3.06	3.09	3.09	3.10	3.12	3.14	3.08	3.00	2.84
		COP	1.41	1.77	2.07	2.26	2.40	2.60	2.74	3.07	3.17	3.39	3.53	3.63	3.75	3.92	4.26
	MIN	Heating Capacity(kW)	2.0	2.4	2.7	2.9	3.0	3.3	3.4	3.8	3.9	4.2	4.3	4.5	4.6	4.6	4.8
		Input power (kW)	0.89	0.91	0.92	0.93	0.94	0.94	0.95	0.96	0.96	0.96	0.97	0.97	0.96	0.93	0.88
		COP	2.28	2.60	2.91	3.07	3.23	3.47	3.60	3.93	4.05	4.32	4.48	4.62	4.76	4.99	5.41
Water temp. outlet55°C	MAX	Heating Capacity(kW)	3.8	4.7	5.6	6.2	6.6	7.2	7.6	8.6	8.9	9.6	10.0	10.4	10.5	10.7	11.0
		Input power (kW)	3.15	3.20	3.26	3.30	3.32	3.34	3.35	3.39	3.40	3.41	3.42	3.44	3.38	3.29	3.11
		COP	1.19	1.47	1.72	1.88	1.99	2.16	2.27	2.55	2.63	2.82	2.93	3.02	3.12	3.26	3.54
	MIN	Heating Capacity(kW)	1.9	2.1	2.5	2.6	2.8	3.0	3.1	3.4	3.6	3.8	4.0	4.1	4.2	4.2	4.4
		Input power (kW)	0.98	0.99	1.01	1.02	1.03	1.04	1.04	1.05	1.05	1.06	1.06	1.07	1.05	1.02	0.97
		COP	1.89	2.16	2.42	2.55	2.69	2.89	2.99	3.27	3.37	3.60	3.73	3.84	3.96	4.15	4.50
Water temp. outlet60°C	MAX	Heating Capacity(kW)	3.5	4.3	5.2	5.7	6.1	6.6	7.0	8.0	8.2	8.8	9.2	9.6	9.7	9.9	10.1
		Input power (kW)	3.34	3.39	3.46	3.50	3.52	3.54	3.56	3.59	3.60	3.61	3.63	3.65	3.59	3.49	3.30
		COP	1.04	1.28	1.49	1.63	1.73	1.88	1.97	2.21	2.29	2.44	2.54	2.62	2.70	2.83	3.07
	MIN	Heating Capacity(kW)	1.7	2.0	2.3	2.4	2.6	2.8	2.9	3.2	3.3	3.5	3.6	3.8	3.8	3.9	4.0
		Input power (kW)	1.03	1.05	1.07	1.08	1.09	1.09	1.10	1.11	1.11	1.12	1.12	1.13	1.11	1.08	1.02

		COP	1.65	1.89	2.11	2.23	2.34	2.52	2.61	2.85	2.94	3.13	3.25	3.35	3.45	3.61	3.92
Water temp. outlet65℃	MAX	Heating Capacity(kW)	/	4.0	4.8	5.3	5.6	6.1	6.5	7.4	7.6	8.2	8.6	8.9	9.0	9.2	9.4
		Input power (kW)	/	3.56	3.63	3.67	3.69	3.71	3.73	3.77	3.78	3.79	3.81	3.83	3.76	3.66	3.47
		COP	/	1.13	1.32	1.44	1.53	1.66	1.74	1.95	2.02	2.16	2.24	2.31	2.39	2.50	2.71
	MIN	Heating Capacity(kW)	/	1.8	2.1	2.2	2.4	2.6	2.7	2.9	3.0	3.2	3.4	3.5	3.5	3.6	3.7
		Input power (kW)	/	1.11	1.13	1.15	1.15	1.16	1.17	1.18	1.18	1.18	1.19	1.20	1.18	1.14	1.08
		COP	/	1.65	1.84	1.94	2.05	2.20	2.28	2.49	2.56	2.74	2.84	2.92	3.01	3.16	3.42
Water temp. outlet70℃	MAX	Heating Capacity(kW)	/	/	4.4	4.9	5.2	5.7	6.0	6.8	7.0	7.5	7.9	8.2	8.3	8.4	8.6
		Input power (kW)	/	/	3.72	3.76	3.79	3.81	3.83	3.87	3.87	3.89	3.91	3.93	3.86	3.76	3.55
		COP	/	/	1.18	1.29	1.37	1.49	1.56	1.75	1.81	1.94	2.01	2.08	2.14	2.24	2.43
	MIN	Heating Capacity(kW)	/	/	1.9	2.1	2.2	2.3	2.4	2.7	2.8	3.0	3.1	3.2	3.3	3.3	3.4
		Input power (kW)	/	/	1.15	1.17	1.17	1.18	1.19	1.20	1.20	1.21	1.21	1.22	1.20	1.17	1.10
		COP	/	/	1.67	1.76	1.85	1.99	2.06	2.25	2.32	2.47	2.56	2.64	2.72	2.85	3.09
Water temp. outlet75℃	MAX	Heating Capacity(kW)	/	/	/	/	/	5.2	5.5	6.2	6.4	6.9	7.2	7.4	7.5	7.7	7.9
		Input power (kW)	/	/	/	/	/	3.90	3.92	3.96	3.97	3.98	4.00	4.03	3.95	3.85	3.64
		COP	/	/	/	/	/	1.32	1.39	1.56	1.61	1.72	1.79	1.85	1.91	2.00	2.17
	MIN	Heating Capacity(kW)	/	/	/	/	/	2.1	2.2	2.5	2.5	2.7	2.8	2.9	3.0	3.0	3.1
		Input power (kW)	/	/	/	/	/	1.20	1.21	1.22	1.22	1.23	1.23	1.24	1.22	1.19	1.12
		COP	/	/	/	/	/	1.78	1.85	2.02	2.08	2.22	2.30	2.37	2.44	2.56	2.78
Ambient temp.(℃)			-25	-20	-15	-12	-10	-7	-5	0	2	5	7	10	12	15	21

Curve of Heating Capacity Performance

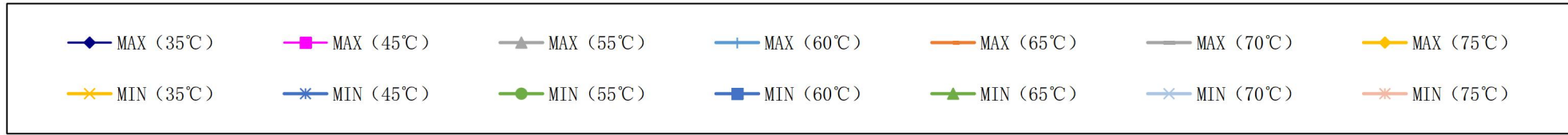
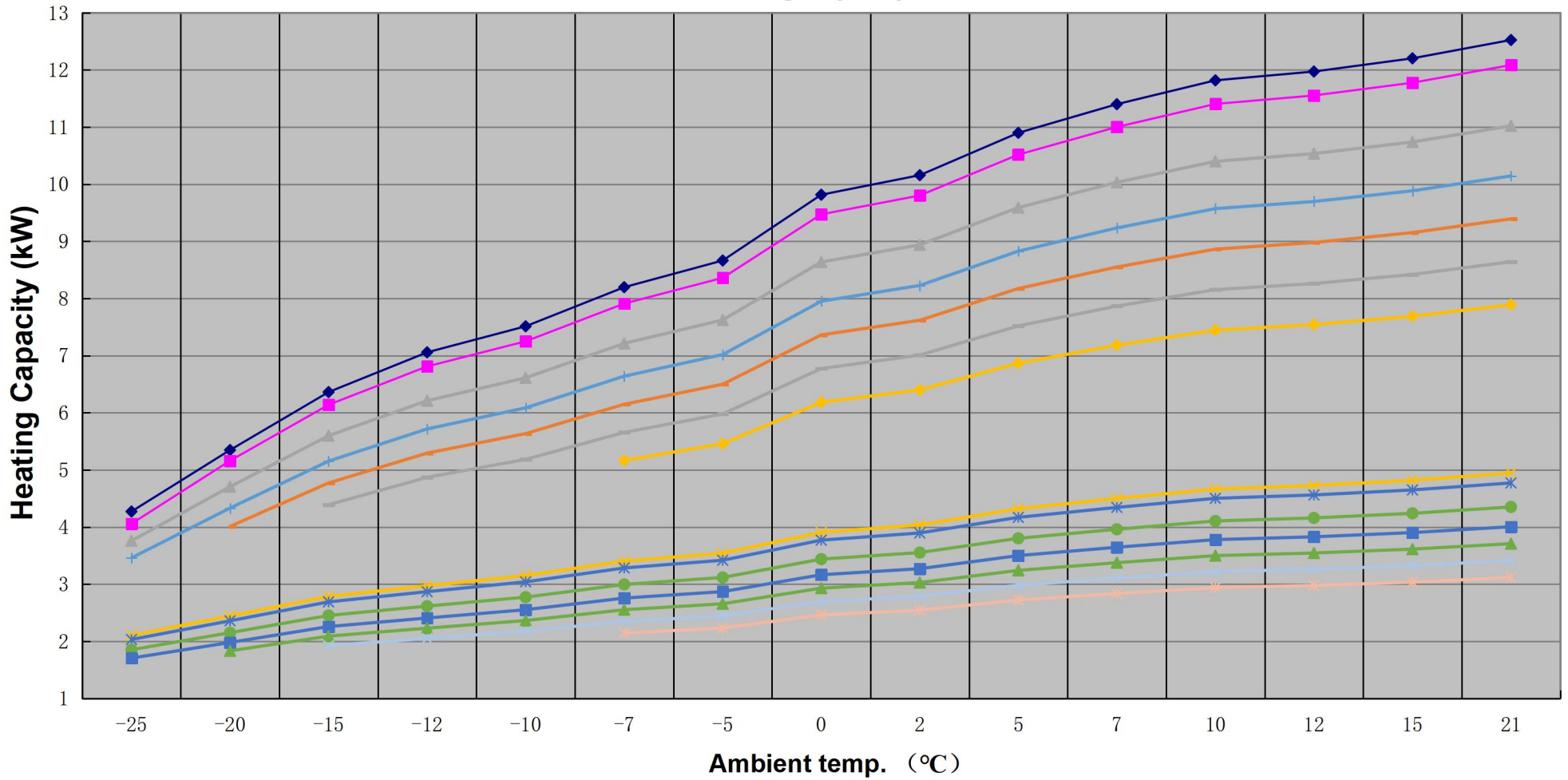

Curve of COP Performance

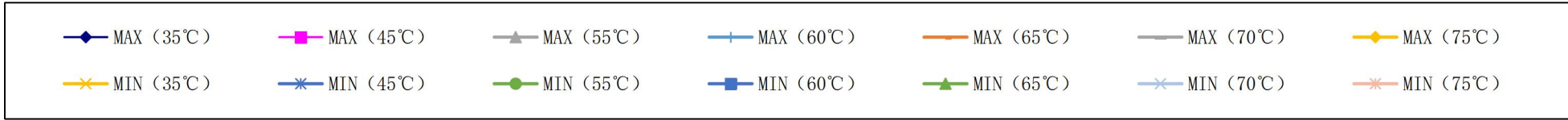
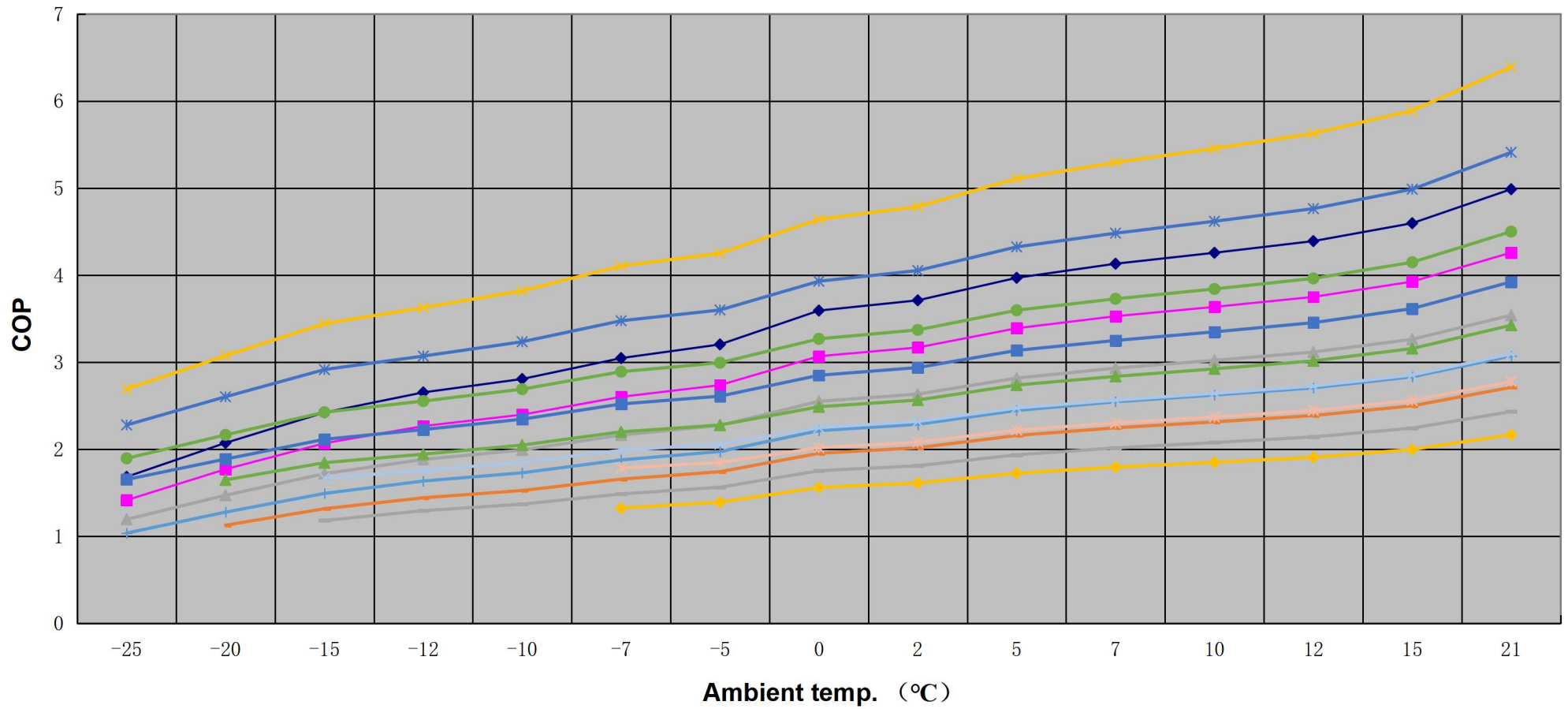

PW050-DKZLRS-E(/S) For heating

Ambient temp.(°C)		-25	-20	-15	-12	-10	-7	-5	0	2	5	7	10	12	15	21	
Water temp. outlet35°C	MAX	Heating Capacity(kW)	5.5	6.9	8.3	9.2	9.8	10.6	11.2	12.7	13.2	14.1	14.8	15.3	15.5	15.8	16.3
		Input power (kW)	3.25	3.30	3.36	3.40	3.42	3.44	3.46	3.49	3.50	3.51	3.53	3.55	3.49	3.40	3.21
		COP	1.71	2.10	2.46	2.69	2.85	3.09	3.25	3.65	3.77	4.03	4.19	4.32	4.46	4.67	5.06
	MIN	Heating Capacity(kW)	2.8	3.2	3.7	3.9	4.1	4.5	4.6	5.1	5.3	5.7	5.9	6.1	6.2	6.3	6.5
		Input power (kW)	1.02	1.04	1.06	1.07	1.08	1.08	1.09	1.10	1.10	1.10	1.11	1.12	1.10	1.07	1.01
		COP	2.70	3.09	3.46	3.64	3.84	4.12	4.27	4.66	4.81	5.13	5.32	5.48	5.65	5.91	6.42
Water temp. outlet45°C	MAX	Heating Capacity(kW)	5.3	6.7	8.0	8.8	9.4	10.3	10.9	12.3	12.7	13.7	14.3	14.8	15.0	15.3	15.7
		Input power (kW)	3.67	3.73	3.80	3.85	3.87	3.89	3.91	3.95	3.96	3.97	3.99	4.01	3.94	3.84	3.63
		COP	1.44	1.80	2.10	2.30	2.43	2.64	2.78	3.11	3.22	3.44	3.58	3.69	3.81	3.98	4.32
	MIN	Heating Capacity(kW)	2.7	3.1	3.5	3.8	4.0	4.3	4.5	4.9	5.1	5.5	5.7	5.9	6.0	6.1	6.3
		Input power (kW)	1.16	1.18	1.20	1.22	1.23	1.23	1.24	1.25	1.26	1.26	1.27	1.27	1.25	1.22	1.15
		COP	2.29	2.61	2.93	3.08	3.25	3.49	3.61	3.94	4.07	4.34	4.50	4.64	4.78	5.01	5.43
Water temp. outlet55°C	MAX	Heating Capacity(kW)	4.9	6.1	7.3	8.1	8.6	9.4	9.9	11.2	11.6	12.5	13.0	13.5	13.7	13.9	14.3
		Input power (kW)	4.03	4.09	4.17	4.22	4.25	4.27	4.29	4.33	4.34	4.36	4.38	4.40	4.32	4.21	3.98
		COP	1.21	1.49	1.74	1.91	2.02	2.19	2.31	2.59	2.67	2.86	2.98	3.07	3.16	3.31	3.59
	MIN	Heating Capacity(kW)	2.4	2.8	3.2	3.4	3.6	3.9	4.1	4.5	4.7	5.0	5.2	5.4	5.5	5.6	5.7
		Input power (kW)	1.28	1.30	1.32	1.34	1.35	1.35	1.36	1.37	1.38	1.38	1.39	1.40	1.37	1.33	1.26
		COP	1.90	2.17	2.43	2.56	2.70	2.90	3.01	3.28	3.38	3.61	3.74	3.86	3.98	4.16	4.52
Water temp. outlet60°C	MAX	Heating Capacity(kW)	4.5	5.6	6.7	7.4	7.9	8.6	9.1	10.3	10.7	11.5	12.0	12.4	12.6	12.8	13.2
		Input power (kW)	4.27	4.34	4.42	4.47	4.50	4.53	4.55	4.60	4.60	4.62	4.64	4.67	4.59	4.47	4.22
		COP	1.05	1.30	1.51	1.66	1.75	1.90	2.00	2.25	2.32	2.48	2.58	2.66	2.74	2.87	3.12
	MIN	Heating Capacity(kW)	2.2	2.6	3.0	3.2	3.3	3.6	3.8	4.1	4.3	4.6	4.8	5.0	5.0	5.1	5.3
		Input power (kW)	1.35	1.37	1.39	1.41	1.42	1.43	1.44	1.45	1.45	1.46	1.47	1.47	1.45	1.41	1.33

		COP	1.66	1.89	2.12	2.23	2.35	2.53	2.62	2.86	2.95	3.15	3.26	3.36	3.47	3.63	3.94
Water temp. outlet65℃	MAX	Heating Capacity(kW)	/	5.2	6.2	6.9	7.3	8.0	8.4	9.6	9.9	10.6	11.1	11.5	11.7	11.9	12.2
		Input power (kW)	/	4.55	4.64	4.70	4.73	4.75	4.77	4.82	4.83	4.85	4.87	4.90	4.81	4.69	4.43
		COP	/	1.14	1.34	1.46	1.55	1.68	1.77	1.98	2.05	2.19	2.28	2.35	2.42	2.54	2.75
	MIN	Heating Capacity(kW)	/	2.4	2.7	2.9	3.1	3.3	3.5	3.8	4.0	4.2	4.4	4.6	4.6	4.7	4.9
		Input power (kW)	/	1.45	1.48	1.50	1.51	1.52	1.52	1.54	1.54	1.55	1.55	1.56	1.54	1.49	1.41
		COP	/	1.65	1.85	1.95	2.05	2.21	2.29	2.50	2.57	2.75	2.85	2.93	3.03	3.17	3.44
Water temp. outlet70℃	MAX	Heating Capacity(kW)	/	/	5.7	6.3	6.7	7.3	7.8	8.8	9.1	9.8	10.2	10.6	10.7	10.9	11.2
		Input power (kW)	/	/	4.76	4.82	4.85	4.87	4.90	4.95	4.95	4.97	4.99	5.02	4.94	4.81	4.55
		COP	/	/	1.20	1.31	1.39	1.51	1.59	1.78	1.84	1.96	2.04	2.11	2.17	2.27	2.47
	MIN	Heating Capacity(kW)	/	/	2.5	2.7	2.8	3.1	3.2	3.5	3.7	3.9	4.1	4.2	4.3	4.4	4.5
		Input power (kW)	/	/	1.51	1.52	1.53	1.54	1.55	1.57	1.57	1.57	1.58	1.59	1.56	1.52	1.44
		COP	/	/	1.67	1.76	1.86	2.00	2.07	2.26	2.33	2.48	2.57	2.65	2.74	2.86	3.11
Water temp. outlet75℃	MAX	Heating Capacity(kW)	/	/	/	/	/	6.7	7.1	8.0	8.3	8.9	9.3	9.7	9.8	10.0	10.2
		Input power (kW)	/	/	/	/	/	4.99	5.02	5.07	5.08	5.09	5.12	5.15	5.06	4.92	4.66
		COP	/	/	/	/	/	1.34	1.41	1.58	1.64	1.75	1.82	1.88	1.94	2.03	2.20
	MIN	Heating Capacity(kW)	/	/	/	/	/	2.8	2.9	3.2	3.3	3.6	3.7	3.9	3.9	4.0	4.1
		Input power (kW)	/	/	/	/	/	1.57	1.58	1.59	1.60	1.60	1.61	1.62	1.59	1.55	1.46
		COP	/	/	/	/	/	1.79	1.85	2.02	2.09	2.23	2.31	2.38	2.45	2.57	2.79
Ambient temp.(℃)			-25	-20	-15	-12	-10	-7	-5	0	2	5	7	10	12	15	21

Curve of Heating Capacity Performance

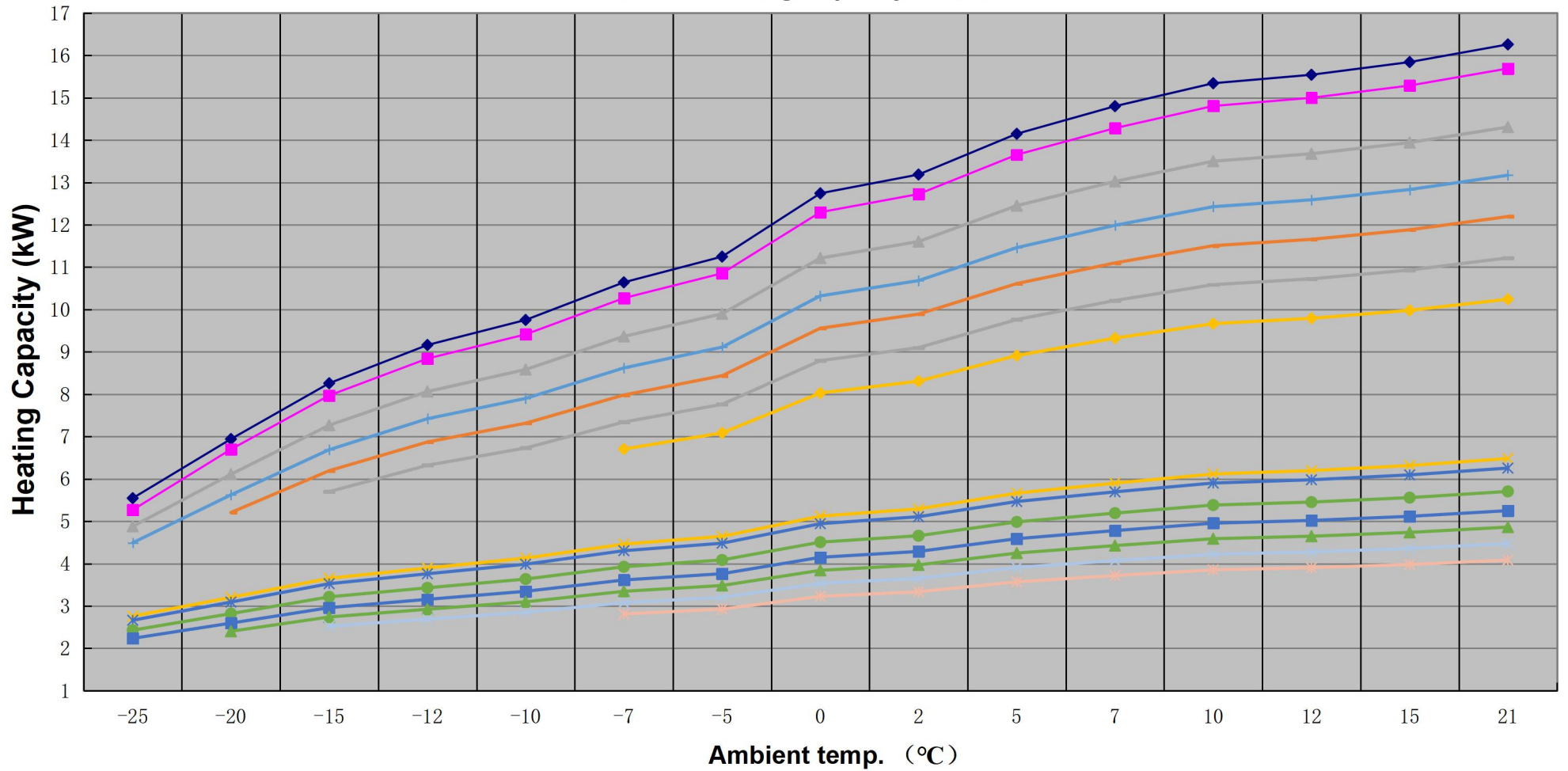

Curve of COP Performance

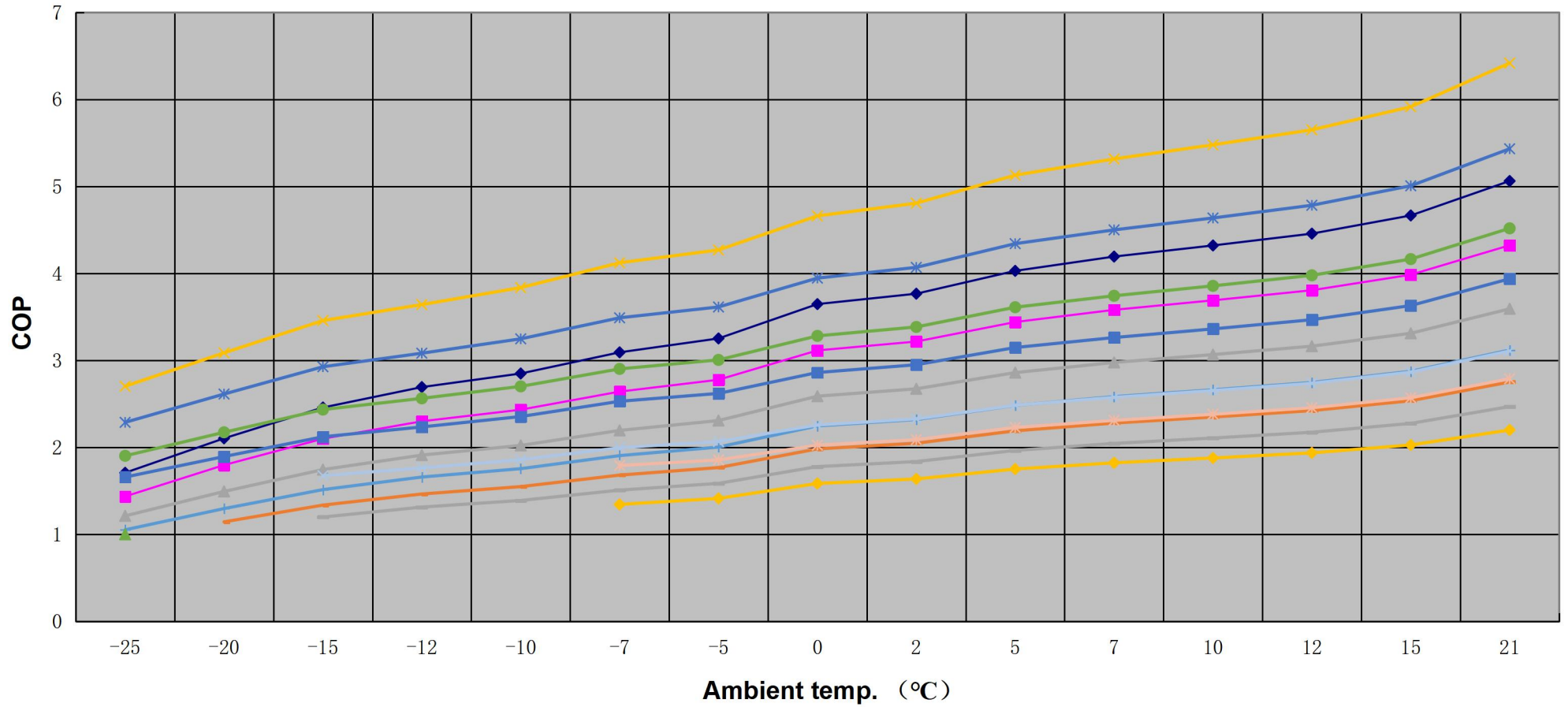

PW060-DKZLRS-E/S For heating

Ambient temp.(°C)		-25	-20	-15	-12	-10	-7	-5	0	2	5	7	10	12	15	21	
Water temp. outlet35°C	MAX	Heating Capacity(kW)	8.2	10.3	12.3	13.6	14.5	15.8	16.7	18.9	19.6	21.0	22.0	22.8	23.1	23.5	24.2
		Input power (kW)	4.87	4.95	5.04	5.10	5.13	5.16	5.18	5.24	5.25	5.26	5.29	5.32	5.23	5.09	4.81
		COP	1.69	2.09	2.44	2.67	2.83	3.07	3.23	3.62	3.74	4.00	4.16	4.29	4.42	4.63	5.02
	MIN	Heating Capacity(kW)	4.1	4.8	5.4	5.8	6.2	6.7	6.9	7.6	7.9	8.4	8.8	9.1	9.2	9.4	9.7
		Input power (kW)	1.53	1.55	1.58	1.60	1.61	1.62	1.63	1.64	1.65	1.65	1.66	1.67	1.64	1.60	1.51
		COP	2.69	3.08	3.45	3.63	3.83	4.11	4.26	4.65	4.79	5.11	5.30	5.46	5.63	5.90	6.40
Water temp. outlet45°C	MAX	Heating Capacity(kW)	7.8	10.0	11.8	13.1	14.0	15.3	16.1	18.3	18.9	20.3	21.2	22.0	22.3	22.7	23.3
		Input power (kW)	5.50	5.59	5.69	5.76	5.80	5.83	5.86	5.92	5.93	5.95	5.98	6.01	5.91	5.75	5.44
		COP	1.42	1.78	2.08	2.28	2.41	2.62	2.75	3.09	3.19	3.41	3.55	3.66	3.77	3.95	4.29
	MIN	Heating Capacity(kW)	4.0	4.6	5.3	5.6	5.9	6.4	6.7	7.4	7.6	8.2	8.5	8.8	8.9	9.1	9.3
		Input power (kW)	1.74	1.77	1.80	1.82	1.84	1.85	1.85	1.87	1.88	1.88	1.89	1.90	1.87	1.82	1.72
		COP	2.28	2.61	2.92	3.07	3.24	3.48	3.60	3.93	4.06	4.33	4.49	4.62	4.77	4.99	5.42
Water temp. outlet55°C	MAX	Heating Capacity(kW)	7.3	9.1	10.8	12.0	12.8	13.9	14.7	16.7	17.2	18.5	19.4	20.1	20.3	20.7	21.3
		Input power (kW)	6.03	6.13	6.24	6.32	6.36	6.40	6.43	6.49	6.51	6.53	6.56	6.60	6.48	6.31	5.97
		COP	1.20	1.48	1.73	1.90	2.01	2.18	2.29	2.57	2.65	2.84	2.95	3.04	3.14	3.28	3.56
	MIN	Heating Capacity(kW)	3.6	4.2	4.8	5.1	5.4	5.9	6.1	6.7	6.9	7.4	7.7	8.0	8.1	8.3	8.5
		Input power (kW)	1.91	1.94	1.98	2.00	2.01	2.02	2.03	2.05	2.06	2.06	2.08	2.09	2.05	2.00	1.89
		COP	1.90	2.17	2.43	2.56	2.69	2.89	3.00	3.27	3.37	3.60	3.73	3.85	3.97	4.15	4.51
Water temp. outlet60°C	MAX	Heating Capacity(kW)	6.7	8.4	9.9	11.0	11.7	12.8	13.5	15.3	15.9	17.0	17.8	18.5	18.7	19.1	19.6
		Input power (kW)	6.40	6.50	6.62	6.71	6.75	6.78	6.82	6.89	6.90	6.92	6.96	7.00	6.87	6.69	6.33
		COP	1.04	1.28	1.50	1.64	1.74	1.89	1.99	2.23	2.30	2.46	2.56	2.64	2.72	2.85	3.09
	MIN	Heating Capacity(kW)	3.3	3.9	4.4	4.7	5.0	5.4	5.6	6.2	6.4	6.8	7.1	7.4	7.5	7.6	7.8
		Input power (kW)	2.02	2.05	2.09	2.11	2.13	2.14	2.15	2.17	2.17	2.18	2.19	2.20	2.16	2.11	1.99

		COP	1.65	1.89	2.12	2.23	2.35	2.52	2.61	2.85	2.94	3.14	3.25	3.35	3.46	3.62	3.93
Water temp. outlet65℃	MAX	Heating Capacity(kW)	/	7.7	9.2	10.2	10.9	11.9	12.5	14.2	14.7	15.8	16.5	17.1	17.3	17.7	18.1
		Input power (kW)	/	6.83	6.95	7.04	7.08	7.12	7.15	7.23	7.24	7.26	7.30	7.34	7.21	7.02	6.64
		COP	/	1.13	1.32	1.45	1.54	1.67	1.75	1.97	2.03	2.17	2.26	2.33	2.40	2.51	2.73
	MIN	Heating Capacity(kW)	/	3.6	4.1	4.4	4.6	5.0	5.2	5.7	5.9	6.3	6.6	6.8	6.9	7.1	7.3
		Input power (kW)	/	2.17	2.21	2.24	2.25	2.27	2.28	2.30	2.31	2.31	2.32	2.34	2.30	2.24	2.11
		COP	/	1.65	1.85	1.95	2.05	2.20	2.28	2.49	2.57	2.74	2.84	2.93	3.02	3.16	3.43
Water temp. outlet70℃	MAX	Heating Capacity(kW)	/	/	8.5	9.4	10.0	10.9	11.5	13.1	13.5	14.5	15.2	15.7	15.9	16.2	16.7
		Input power (kW)	/	/	7.13	7.22	7.26	7.30	7.34	7.41	7.43	7.45	7.49	7.53	7.40	7.20	6.81
		COP	/	/	1.19	1.30	1.38	1.50	1.57	1.76	1.82	1.95	2.03	2.09	2.16	2.26	2.45
	MIN	Heating Capacity(kW)	/	/	3.8	4.0	4.3	4.6	4.8	5.3	5.4	5.8	6.1	6.3	6.4	6.5	6.7
		Input power (kW)	/	/	2.25	2.28	2.29	2.31	2.32	2.34	2.35	2.35	2.37	2.38	2.34	2.28	2.15
		COP	/	/	1.67	1.76	1.85	1.99	2.06	2.25	2.32	2.48	2.57	2.65	2.73	2.86	3.10
Water temp. outlet75℃	MAX	Heating Capacity(kW)	/	/	/	/	/	10.0	10.5	11.9	12.3	13.3	13.9	14.4	14.6	14.8	15.2
		Input power (kW)	/	/	/	/	/	7.48	7.52	7.59	7.61	7.63	7.67	7.72	7.58	7.38	6.98
		COP	/	/	/	/	/	1.33	1.40	1.57	1.62	1.74	1.81	1.86	1.92	2.01	2.18
	MIN	Heating Capacity(kW)	/	/	/	/	/	4.2	4.4	4.8	5.0	5.3	5.5	5.7	5.8	5.9	6.1
		Input power (kW)	/	/	/	/	/	2.35	2.36	2.38	2.39	2.39	2.41	2.42	2.38	2.32	2.19
		COP	/	/	/	/	/	1.79	1.85	2.02	2.08	2.22	2.30	2.37	2.45	2.56	2.78
Ambient temp.(℃)			-25	-20	-15	-12	-10	-7	-5	0	2	5	7	10	12	15	21

Curve of Heating Capacity Performance

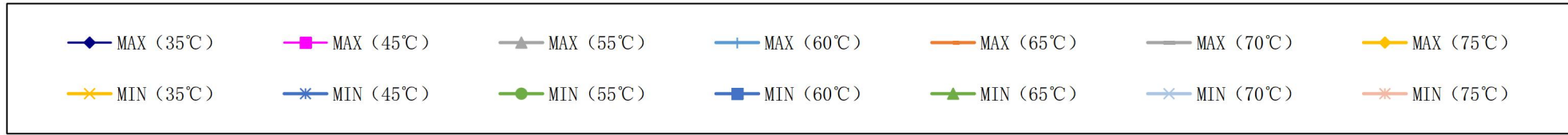
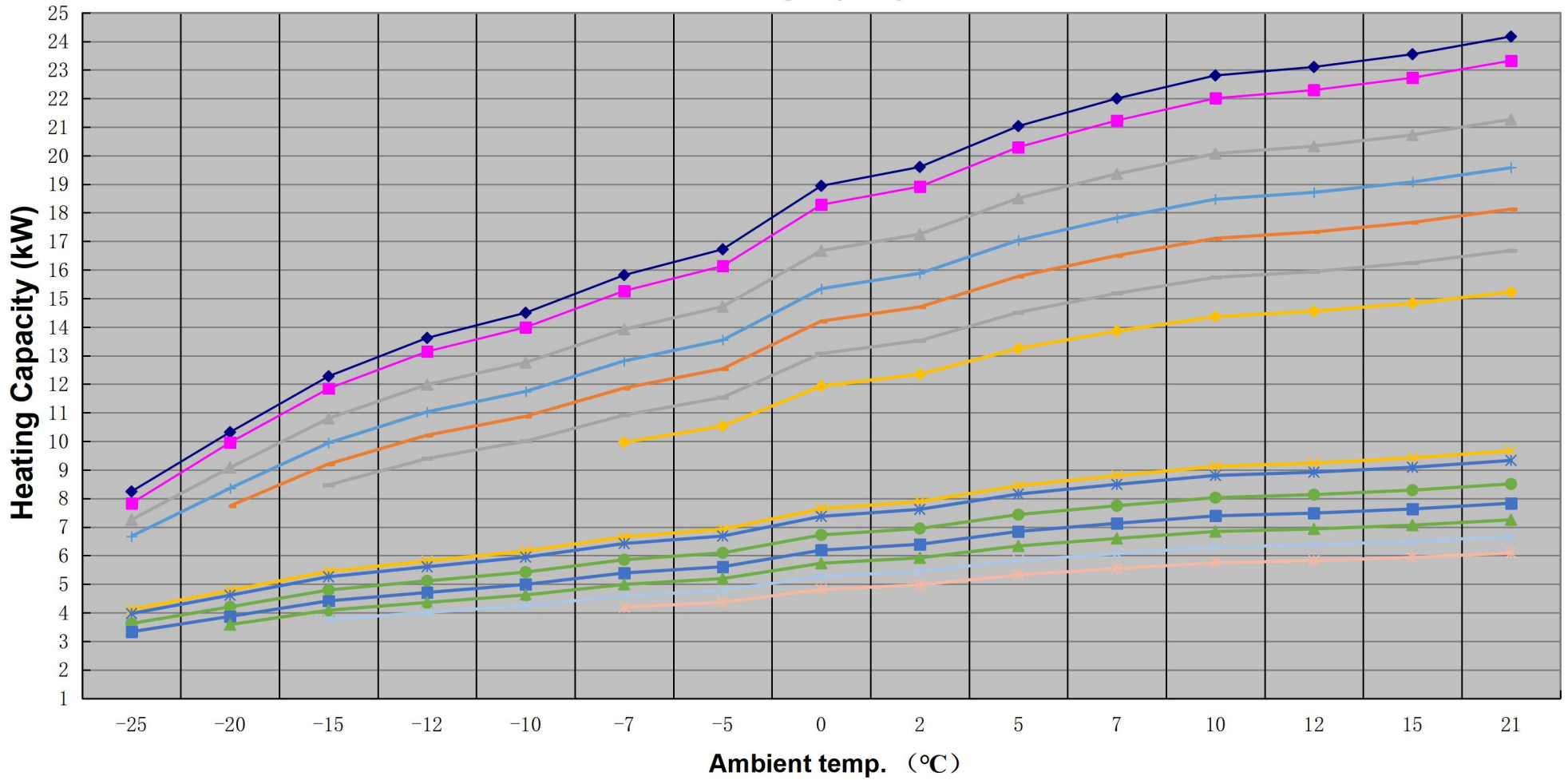

Curve of COP Performance

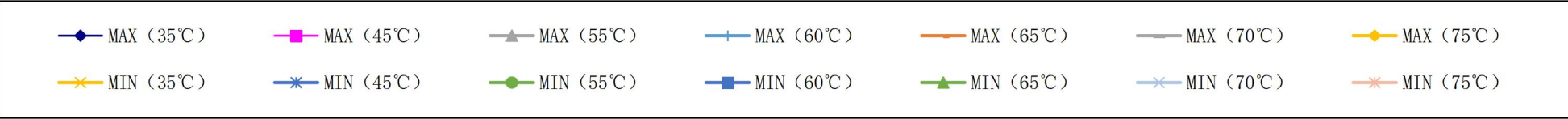
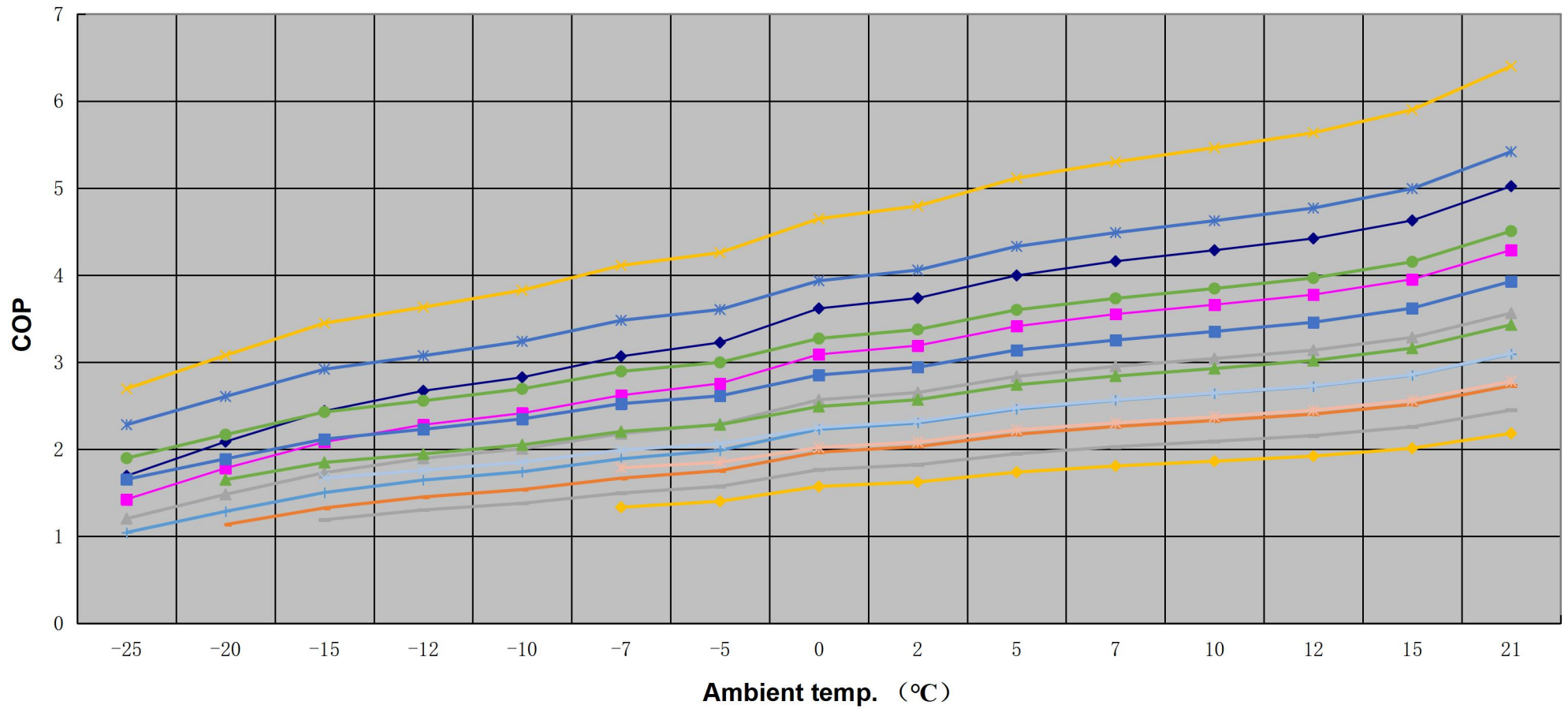















10. Display Operation Guide

10.1. Controller Panel

















10.2. Display Icon

Mode	Meaning
	Heating mode
	Hot water mode
	Cooling mode
	Heating and Hot water Mode (Hot water function as priority)
	Cooling and Hot water Mode (Hot water function as priority)
	Smart mode
	Power mode
	Silent mode
	Vacation mode
	Compressor working

	Water pump working
	Fan motor working
	Electric heating working
	Defrosting
	Antifreezing

10.3. Definition of Buttons

Button	Description	Function
	On/off	turn on or turn off the heat pump.
	Mode	switch the operating mode of the heat pump.
	Timer	set timer switch and working weekdays.
	Setting	query running parameters, check and set system parameters, error code records, Wifi connection, etc.
	Temperature setting 1	Temperature setting for only hot water, only heating and only cooling mode (the interface displays the inlet water temperature and outlet water temperature)
	Temperature setting 2	In hot water+heating or hot water+cooling mode , the left side is temperature setting for heating and cooling, and the right side is temperature setting for hot water (the main interface temperature display shows on the left side is inlet water temperature, and on the right side is water tank temperature)
	Status	Check the running parameters of the heat pump

	Faulty	Record the most recent error codes
	Wifi	Wifi setting
	User parameters	Check and set the user parameters of the heat pump
	Factory parameters	Check and set the factory parameters(Do not advise to amend the factory parameters.
	Run the curve	Check the inlet water and outlet water operation curves and operation power curves.
	System parameters	Check the version information of the system motherboard and the remote control program.
	Language	Language selection

10.4. Wire Controller Operation

10.4.1. START / STOP THE HEAT PUMP

©In the main interface, press the "ON/OFF" key for 1 second, and the "Startup Confirmation" pop-up window pops up. After the startup is confirmed, the mode symbol is displayed in the startup status, but not in the shutdown status.



SET TARGET WATER TEMPERATURE

In single mode (only cooling, only heating, only hot water mode), click "+" and "-" on the main interface to adjust the required temperature; in dual mode (heating+hot water, cooling+hot water mode), click "+" and "-" on the left side of the main interface to adjust the required heating and cooling temperature; click "+" and "-" on the right side to adjust the required hot water temperature.



10.4.2. RUNNING MODE SETTING/OPERATING MODE SELECTION

In the main interface, press the "MODE" key for 1 second to enter the operation mode, frequency mode and holiday mode selection interface, and select the required operation mode (parameter setting model) and frequency mode of the unit;

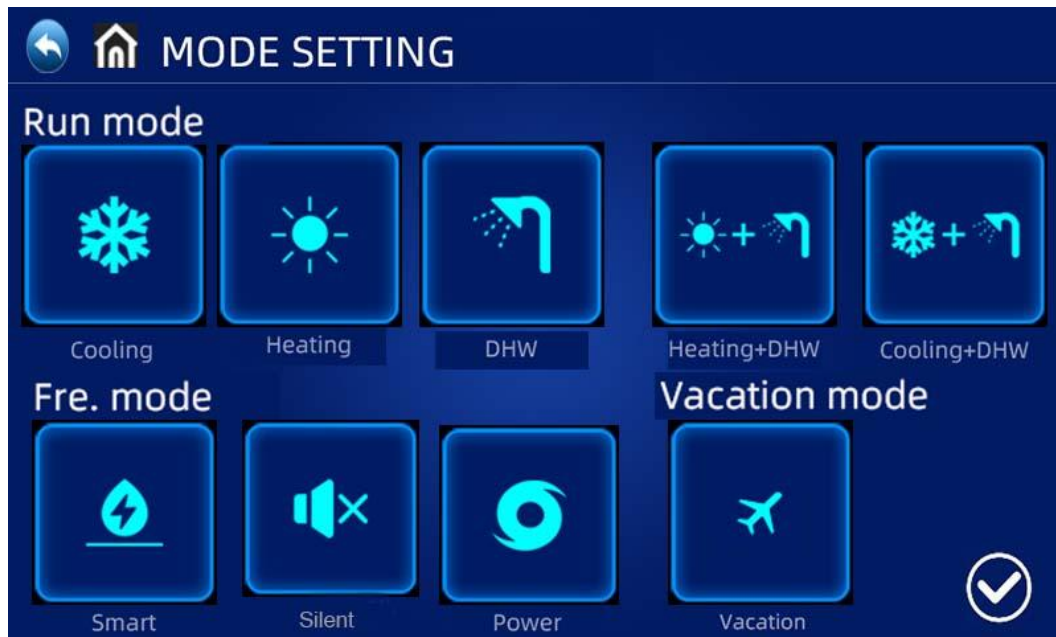

©Click“ MODE”on the Setting interface to enter Operating mode selection interface;

©Operating mode description: In the normal mode, Heat pump has Smart,Powerful,& Silent Operating states to choose.

©Vacation mode description: When this mode is enabled,The heat pump runs in heating mode only,with a Target temperature of vacation Set.

10.4.3. CLOCK SETTING

©In the main interface, press **2022/11/1 15:00 TUE** to enter clock setting interface as below.

©Press the date (Year/Month/Day column) or hour (Hour:Minute column) , the keyboard will occur to input the value. Press the weekday(Weekday column) to switch from Mon. to Sun.

©Press CONFIRM button to save and exit, or press CANCEL button to exit without saving.

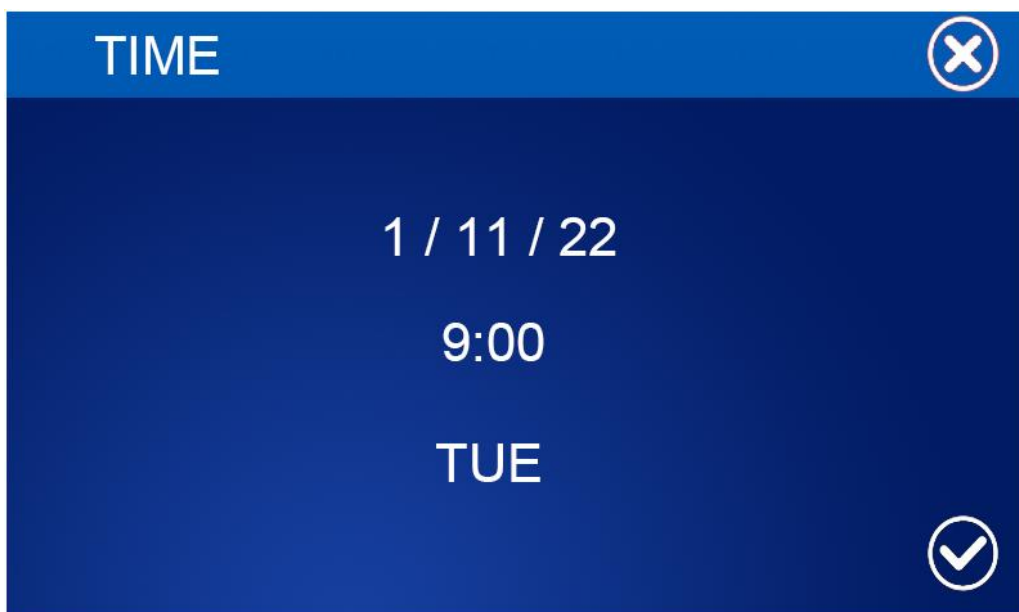

10.4.4. TIMER SETTING

© In the main interface, press TIMER button to enter timing setting interface.

© In the WEEK column, users can select which weekdays to perform timer switch. When the weekday button (From MON. to SUN.) turns highlight white, the timer will perform on that day. When the weekday button turns gray, the timer will not perform on that day.

© In the TIMER column, users can set 4 pairs of timer at maximum

© The timer is invalid when the turn on time equals the turn off time in the same timer.



SILENT TIME:



© Click “” in the “SET TIME” Interface to enter Timing silent interface, The unit will runs as Silent Mode during the scheduled mute time.

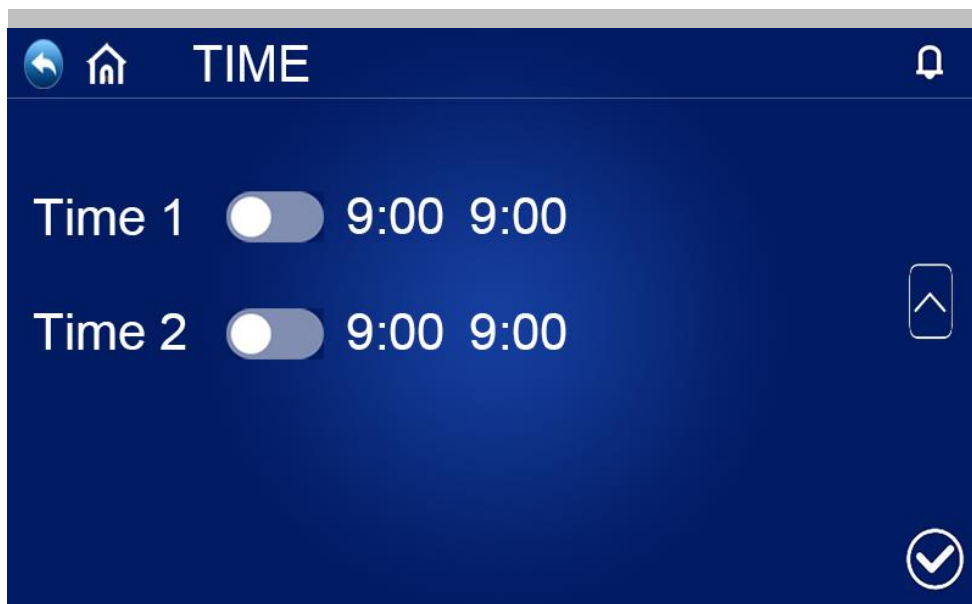

10.4.5. OPERATION PARAMETER QUERY

Press the "SETTING" key in the main interface to enter the setting interface. Then press "UNIT STATUS" to enter the unit list interface, select the corresponding unit to enter the "Parameter Query", and check the operation status of the heat pump. The status table is as follows:

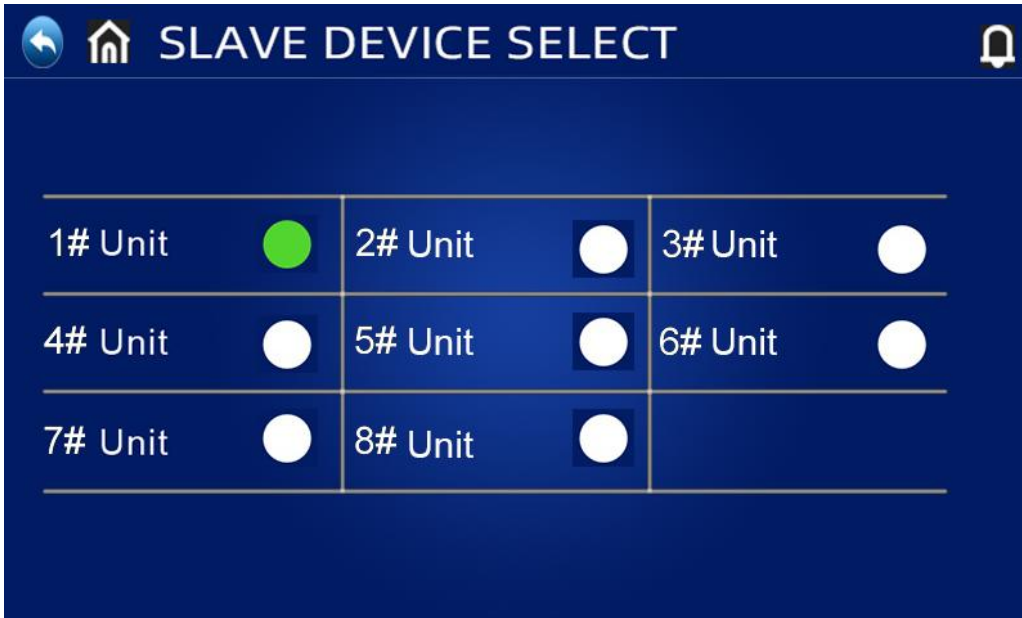

The screenshot shows a mobile application interface titled "SLAVE DEVICE SELECT". It features a dark blue background with a white header bar containing a home icon, a back arrow, and a notification bell. Below the header is a table with three columns and three rows. Each cell in the table contains a unit number followed by a colored circle representing its status: green for "On" and white for "Off".

Unit	Status	Unit	Status	Unit	Status
1# Unit	●	2# Unit	●	3# Unit	●
4# Unit	●	5# Unit	●	6# Unit	●
7# Unit	●	8# Unit	●		

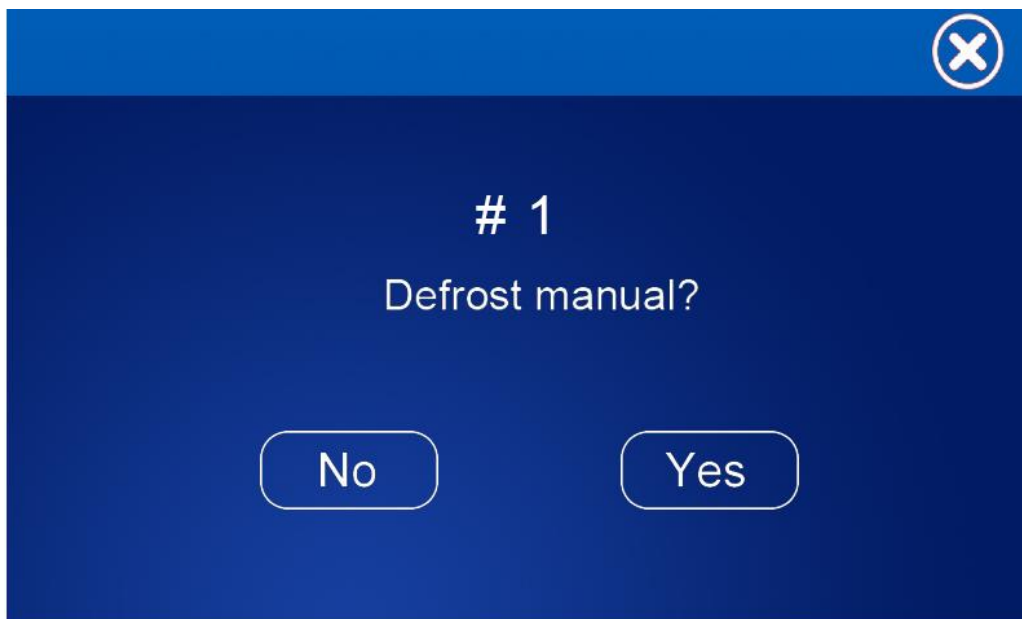

Forced defrosting: In the unit selection interface of the query status, press and hold the corresponding unit number to pop up the forced defrosting selection interface of the corresponding unit. If Yes is selected, the corresponding unit enters forced defrosting.



©List of operation parameters

Code	Description	Remark
01	Water inlet temp.	-30~99℃
02	Water outlet temp.	-30~99℃
03	Ambient temp.	-30~99℃
04	Exhaust gas temp.	0~125℃
05	Return gas temp.	-30~99℃
06	Evaporator coil temp.	-30~99℃
07	Inlet temp. of economizer	-30~99℃
08	Outlet temp. of economizer	-30~99℃
09	Cooling coil temp.	-30~99℃
10	Water tank temp.	-30~99℃
11	Opening of main expansion valve	
12	Opening of assistant expansion valve	
13	Compressor current	
14	Heat sink temp.	
15	Compress target frequency	
16	Compress actual frequency	
17	Low pressure gauge pressure value (R290)	Real time data(Bar)
18	Low pressure conversion temp.	
19	Wind speed of DC fan 1	
20	Wind speed of DC fan 2	
21	EUV powered signal	
22	SG grid signals	
24	DC bus voltage value	
25	Heating Capacity	
26	Current water flow Volume	
27	Current of the entire machine	
28	Voltage	
29	Power Rate	
30	COP(EER)	
31	Target rotation speed of DC water pump	
32	DC pump speed	

View Power Consumption Curve

Press the "SETTING" key in the main interface to enter the setting interface. Then click "Run the curve" to enter the power consumption curve interface, click  and  at the bottom of the interface to view "temperature curve", "operating power curve", "COP curve", "heating capacity", "daily power consumption curve", "monthly power consumption curve", "annual power consumption curve".

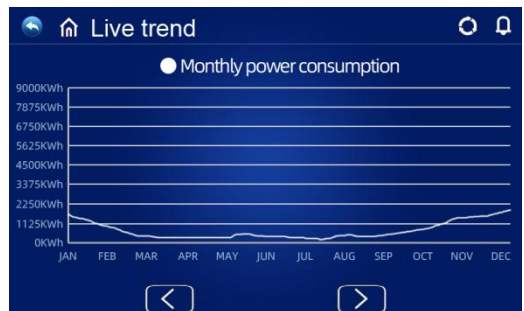
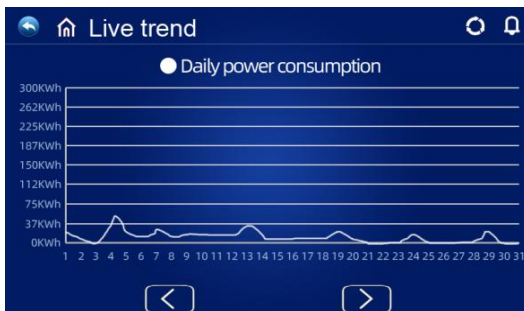
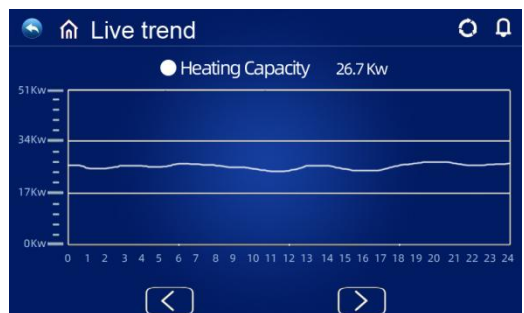
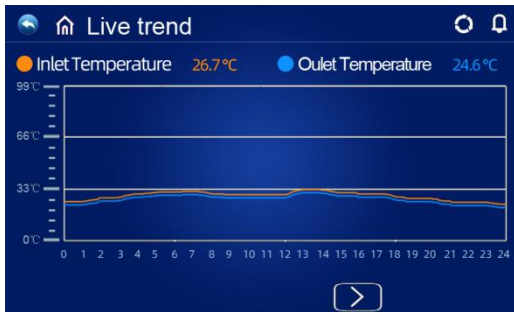

10.5. User Parameter Query & Setting

© Press “SETTING” in the main interface to enter setting interface, then press “USER PARAMETERS” to enter parameter query and setting. Below lists shows the code, definition, range and default value.

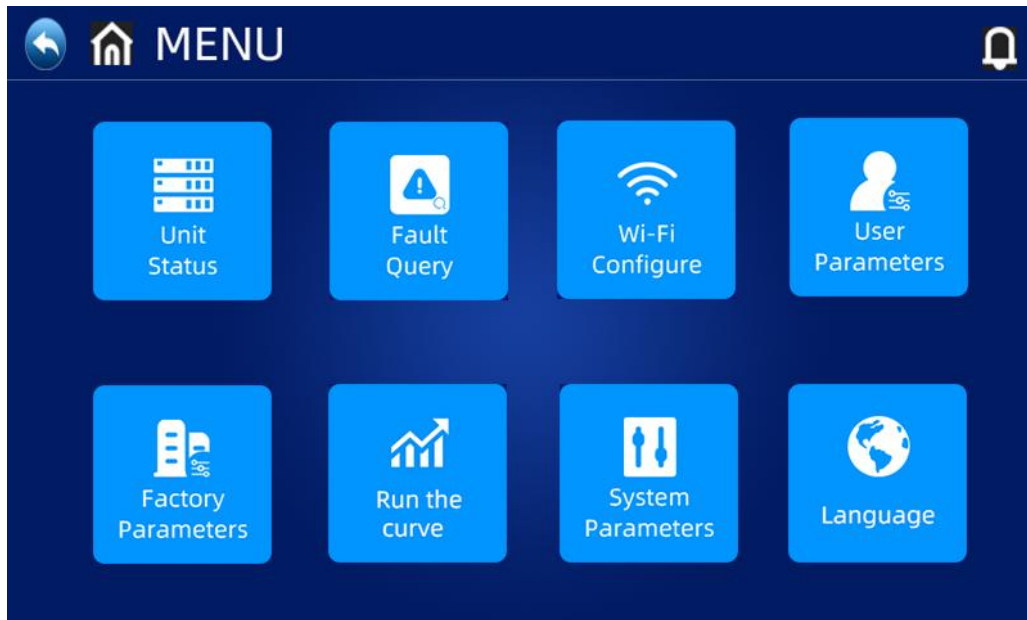

© List of user parameters

Code	Definition	Settable Range	Default
P01	Temp difference of return water and cooling target temp	2°C~18°C	2°C
P02	Temp difference of return water and hot water target temp	2°C~18°C	5°C
P03	Hot water setting temp.	28°C~70°C	50°C
P04	Cooling setting temp.	7°C~30°C	12°C
P05	Heating setting temp.	15°C~70°C	35°C
P06	Setting temp of exhaust gas too high protection (TP4)	50°C~125°C	120°C
P07	Setting temp of exhaust gas too high recover (tp0)	50°C~125°C	95°C
P08	Water temp. compensation	-5°C~15°C	(inlet/outlet water & water tank)
P09	Defrosting frequency	30-120HZ	60HZ
P10	Defrosting period	20MIN~90MIN	45MIN

P11	Defrosting enter temp.	-15°C~-1°C	-3°C
P12	Defrosting time	5MIN~20MIN	10MIN
P13	Defrost exit temp.	1°C~40°C	20°C
P14	Defrosting environment and evaporator coil temp. difference 1	0°C~15°C	5°C
P15	Defrosting environment and evaporator coil temp. difference 2	0°C~15°C	5°C
P16	Ambient temp. for defrosting	0°C~20°C	17°C
P17	High temperature disinfection cycle days	0~30 days Disinfection function is not executed when set to 0	7
P18	High temperature disinfection start time	0~23:00	23
P19	High temperature disinfection sustaining time	0~90min	30
P20	High temperature disinfection setting temperature	0~90°C	70°C
P21	Heat pump's setting temperature for high temperature disinfection	40~60°C	53°C
	Celsius/Fahrenheit switch	0 Celsius/1 Fahrenheit	0
P22	Heating target temperature automatic adjustment enable	0~1 (0 is not enabled, 1 is enabled) (only applicable at heating mode)	0
P23	Heating compensation temperature point (ambient temperature)	0-40	20
P24	Target temperature compensation coefficient	1~30 (1 corresponds to actual 0.1)	1
P25	Compressor's Frequency operation mode after constant Temperature	0-Decrease Frequency after constant Temp. /1-Non Decrease Frequency after constant Temp.	0
P26	Ambient temperature for starting	-20-20°C	0

	electric heating		
P27	Start time for electric heating of water tank	0-60 min	30
F01	Heat Pump Function	1 Heating only 2 Heating+Cooling 3 Heating+DHW 4 Heating+Cooling+DHW	4
F02	Circulation pump status after reaching target temp.	0 Intermittent 1 All time 2 Stop at constant Temp.	1
F03	Circulation pump on-off cycle after reaching set temp.	1~120min	30(OFF30min ON3min)
F04	DC circulation pump mode	0 No Start 1 Auto 2 Manual	1
F05	DC circulation pump adjustment cycle	10~100S	60
F06	DC water pump manual speed	10~100%	50
F08	Minimum speed of DC circulation pump	10~100%	40
P28	On-line units	1~8	1
P29	Control address	1~255	1
S1	Smart grid capabilities	No、 Yes	No
S2	SG operating time	0-600 min	180min

10.6. Restore factory settings

In the upper right corner of the factory parameter R interface, there is a parameter reset factory value button. Press this button to pop up the reset parameter confirmation selection. If Yes is selected, the factory default value will be restored;



10.7. High Temperature Antiseptis Function: (when hot water function is selected)

- ◎ High temperature Antiseptis cycle is once every 7 (P17) days;
- ◎ When entering the high temperature Antiseptis, the water tank electric heater will be forced to turn on.
- ◎ During the Antiseptis process, if the water tank temperature $> 65^{\circ}\text{C}$ (the maximum settable temperature), then the compressor will not start, but only start electric heating; If the water tank temperature $\leq 60^{\circ}\text{C}$, both the compressor and electric heater will start.
- ◎ When the water tank temperature $\geq 70^{\circ}\text{C}$ (P20) and the protection temperature lasts for 30 minutes (P19), exit the high temperature Antiseptis;
- ◎ After entering high temperature Antiseptis, if the temperature of the hot water tank does not reach 70°C after 1 hour, the high temperature Antiseptis program will be forced to exit.

10.8. Target Temperature Auto Adjustment Logic (Under Heating Mode)

◎ The target temperature under heating mode can be automatically adjusted according to the ambient temperature.

◎ Entry conditions

When Parameter P22=1 enables automatic adjustment mode of heating target temperature.

◎ Calculation formula of heating target temperature

$Pset(\text{heating target temperature}) = 20 + (P24/10) * (P23 - \text{current ambient temperature})$

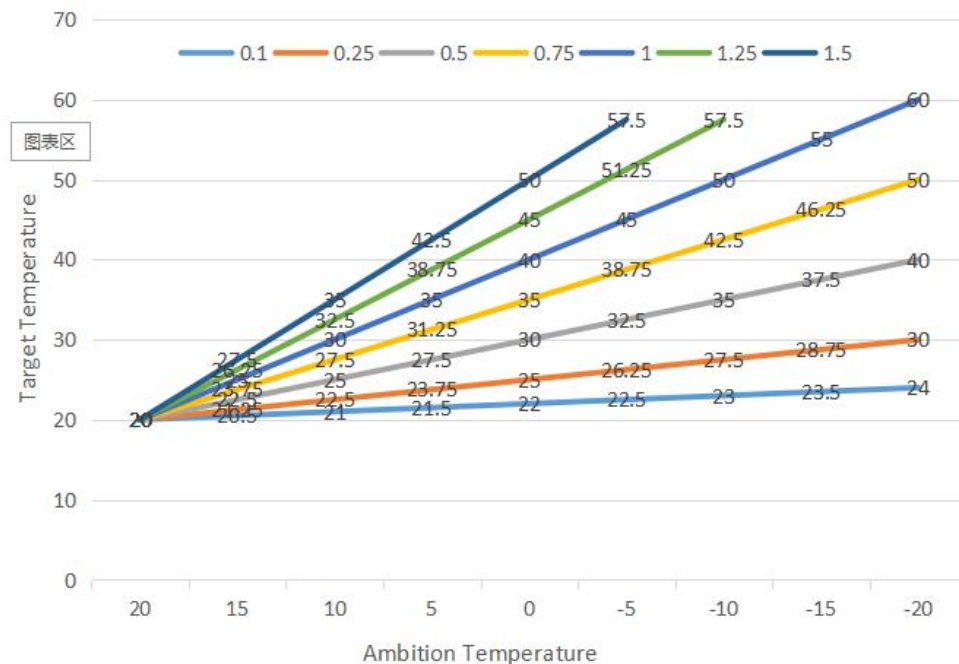

◎ The above different curves stands for the different value of P24.

(When P24=1, the actual value is 0.1)

◎ The target temperature range of automatic temperature adjustment is 20-70°C

10.9. Auxiliary Electric Heater for Water Tank

◎ Start conditions (all below conditions must be met at the same time)

- 1) In hot water mode;
- 2) The compressor runs for P27(30)minutes;
- 3) There is a demand for hot water, and the temperature of the water tank is $\leq 70^\circ\text{C}$;
- 4) The pump is running

◎ Exit condition (only need to meet any one of the below conditions)

- 1) When the heat pump is performing cooling mode / hot water mode;
- 2) When there is no demand for hot water or constant temperature control;

3) The water tank temperature sensor has a fault alarm;

◎ When it is under defrosting / forced defrosting / secondary antifreeze , the electric heating is forced to turn on;

◎ When there is high-pressure failure / low-pressure failure / exhaust temperature sense failure / excessive exhaust protection stop, and if compressor is locked and cannot be started, then the electric heating will be started instead of the compressor after 5 minutes.

10.10. Auxiliary Electric Heater for Space heating

◎ Enable condition:

Under Heating mode;

Ambient Temp. < P26(0°C) Or Ambient Temp. Sensor Fault

There has Heating Demand, Inlet Water Temp. ≤ Heating Set Temp. (P05) - Restart difference(P01);

Water pump during Working States

When the above conditions are met, The Electric Heater will turn on.

◎ Shut-down condition:

Under Cooling or Hot Water Mode

Without Heating Demand or Constant Temp. Control

Inlet Water Temp. Sensor Failure or Alarm

Ambient Temp. > 0°C (P26)+1

Water Flow Failures

Circulation pump shut-down

E-heater be shut-down when any of above conditions met

SMART GRID

◎ When the smart grid function parameter is selected to be enabled (S01 = 1), the heat pump starts running the smart grid function

SMART GRID		
Operating State	SG	EVU
Increased operation	ON	ON
	OFF	ON
Normal operation	ON	OFF
Decreased operation	OFF	OFF

1) When SG signal is on, and EVU signal is on, when the hot water mode is set to be valid, heat pump will operate hot water mode priority and the hot water mode setting temperature will be change to 70°C. (Water tank temp.) < 69, the TBH is on, (Water tank temp.) ≥ 70, the TBH is off.

- 2) When SG signal is off, and EVU signal is on, when the hot water mode is set to be valid and the mode is on, heat pump will operate hot water mode priority. (Water tank temp.) < P03-P02, the TBH is on, (Water tank temp.) ≥ P03+2, the TBH is off.
- 3) When SG signal is on, and EVU signal is off, the unit operates normally.
- 4) 4When SG signal is off, and EVU signal is off, the unit will not operate hot water mode, and the TBH is invalid, disinfect function is invalid. The max running time for cooling/heating is 'SG operating time', and then unit will be off.

*** TBH: Water tank heater**

10.11. General Operating Guide

Initial Start-up Precautions

First boot-strap and Running state checks

10.11.1. To ensure the power same as the product nameplate required power.

10.11.2. Unit electrical connections: Check if power supply wire track and connection is ok; if ground wire is properly connected; Check if water pump and other chain device is properly connected

10.11.3. Water pipe and pipe: water pipe and pipe must be washed two and three times, ensure clean and no any pollution.

10.11.4. Check water system: If the water is enough and no any air, ensure no leakage

10.11.5. First boot-strap or starting up again after long time stop, ensure power on ahead and heating at least 12 hours for crankcase (local loop temp. is zero). Water pump start up first, last a while, fan start up, compressor start up, unit regular work.

10.11.6. Running checks (according to the following data to check if the unit running is normal)

After unit normal running, check the following item:

- a. Input and output water temp.
- b. cycle water flow of the side
- c. running electric current of compressor and fan
- d. High and low pressure value when heating running.



CAUTION — Refrain from using this heat pump if any electrical components have been in contact with water. Immediately call a qualified service technician to inspect the heat pump.



CAUTION — Keep all objects clear above the heat pump. Blocking air flow could damage the unit and may void the warranty.

10.12. Users' Guide

10.12.1. Rights and Responsibility

① To ensure you have the service in guarantee period, only the professional server and technology staff can install and repair the unit. If you infract this request and cause any loss and damage, our company will not be claimed any responsibility.

② After receiving the unit, check if have damage on shipment and all parts are complete; any damage and lack of parts please notice the dealer in written.

10.12.2. User's Guide

① All safety protection device are set in unit before leaving factory, don't adjust by yourself.

② Unit have enough refrigerant and lubricating oil, don't fill or replace them; if need fill owing to leak, please refer to the quantity on nameplate (if refill refrigerant, need re-vacuum).

③ External water pump must connect with the message of unit, or else easy show various water lack alarm.

④ Regular clean water system according to maintenance request.

⑤ Pay attention to antifreeze when the environment temp. is less than zero in winter.

⑥ Safety Precautions

A User can't self-install the unit, ensure agent or specialized install company to do, or else maybe cause safety accident and affect the use effect.

B When install or use the unit, please check if the power is corresponding with unit power.

C The main power switch of unit should install leakage protector; the power cord must meet unit power request and national standard and local Fire & Safety Regulations.

D Unit must have ground wire; don't use the unit if no ground wire; forbid connect the ground wire to null line or water pump.

E The main power switch of unit should set much higher 1.4 meter (child don't touch it), to prevent child play it and cause danger.

F More than 52°C hot water can cause damage, hot and cold water must be mixed then use it.

G When unit is soaking, please contact the factory or maintain department, you can use it again after maintain.

H Forbid insert any tools into fan fence of unit, fan is dangerous. (child special care)

I Don't use the unit if turn off the fan fence.

J To avoid electric shock or cause fire, don't store and use fixture, oil paint and petrol etc. combustible gas or liquid around the unit; don't throw the water or other liquid on the unit and don't touch the unit by wet hand.

K Don't adjust the switch, valve, controller and internal data except company server or authorized staff.

L If safety protection device often start up, please contact factory or local dealer.

11. Failure List & Troubleshooting

11.1. Controller Error Codes

©If there's error in the heat pumps, the error code and error definition will be displayed in the main interface, and saved the record in FAULTY column inside the SETTING interface.

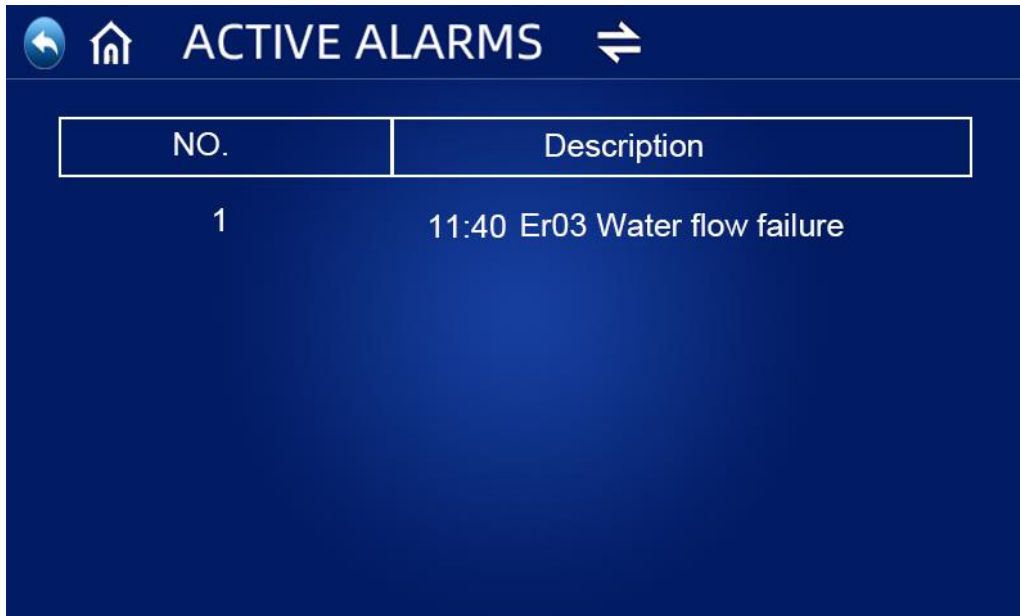

©The following Common Error Codes will be displayed on the controller panel:

Error Code	Definition of Error or Protection
Er 03	Water flow failure
Er 04	Antifreeze in winter
Er 05	High pressure fault
Er 06	Low pressure fault
Er 09	Communication failure
Er 10	Communication failure of frequency conversion module (alarm when communication between outer board and drive board is disconnected)
Er 12	Exhaust temp too high protection
Er 14	Water tank temp. sensor fault
Er 15	Water inlet temp. sensor fault
Er 16	Evaporator coil temp. sensor fault

Er 18	Exhaust temp. fault
Er 20	Abnormal protection of frequency conversion module
Er 21	Ambient temp. sensor fault
Er 23	Cooling outlet water temp. supercooling protection
Er 26	Heat sink temp. fault
Er 27	Outlet water temp. sensor fault
Er 29	Return gas temp. sensor fault
Er 32	Heating too high outlet water temp. protection
Er 33	Coil temp. too high
Er 34	The temp. of frequency conversion module is too high
Er 42	Cooling coil temp. sensor failure
Er 62	Inlet temp. fault of economizer
Er 63	Outlet temp. failure of economizer
Er 64	DC fan 1 fault
Er 66	DC fan 2 fault
Er 67	Low pressure switch failure
Er 68	High pressure switch failure
Er 69	Too low pressure protection
Er 70	Too high pressure protection

© When there's Er 20 error in the system, it will display below detailed error code from 1 to 348. Among them, 1~128 are in the first class, when will be displayed as priority, 257~384 are in the second class, which will be displayed only when error 1~128 don't appear. If 2 or more than 2 error occurs simultaneously in the same class, then it will display the sum of the error number. For example, when 16 and 32 exist at the same time, then it will display error code 48 (16+32=48)

© Detailed error code list for Er 20:

Error Code	name	description	Solution suggestion
1	IPM Over-current	IPM Module problem	Replace inverter module
2	compressor synchronous abnormal	Compressor failure	Replace compressor
4	reserved	--	--
8	compressor output phase absent	Compressor wiring disconnected or poor contact	Checking compressor input circuit
16	DC bus low voltage	Input too low voltage, PFC module failure,	Inspect the input voltage, replace module
32	DC bus high voltage	Input voltage too high, PFC Module failure	Replace inverter module
64	Radiator over temperature	Main unit fan motor failure, air duct blockage	Inspect fan motor, air duct
128	Radiator temperature error	Radiator sensor short circuit or open circuit fault	Replace inverter module
257	communication failure	Inverter module doesn't receive order from main controller	Inspect the communication wiring= between main controller and inverter module
258	AC Input phase absent	Input phase absent (Three phase module is effective)	Inspection input circuit
260	AC Input over-current	Input three phase imbalance (three phase module is effective)	Inspection input three phase phase voltage
264	AC Input low voltage	Input low voltage	Inspect input voltage
272	Compressor High pressure failure	Compressor high pressure failure (reserved)	
288	IPM too high temperature	Main unit fan motor failure, air duct blocked	Inspect fan motor and air duct
320	Compressor peak current too high	Compressor line current too high, the driver program doesn't match with compressor	Replace inverter module
384	PFC module over-temperature	PFC Module too high temperature	

11.2. Owner Inspection

We recommend that inspections on heat pumps are done frequently, especially after abnormal

weather conditions. The following basic guidelines are suggested for your inspection:

1. Make sure the front of the unit is accessible for future service.
2. Keep the top and surrounding areas of the heat pump clear of all debris.
3. Keep all plants and shrubs trimmed and away from the heat pump especially the area above the fan.
4. Keep lawn sprinklers from spraying on the heat pump to prevent corrosion and damage.
5. Ensure that the ground wire is always properly connected.
6. The filter must be maintained on a regular basis in order to ensure clean and healthy water to protect the heat pump from damaging.
7. Keep inspecting power and electrical components' wiring to make sure their normal operation.
8. All the safety protection devices have been set up; please refrain from changing these settings. If any changes are needed, please contact the authorized installer/agent.
9. If the heat pump is installed under roof without a gutter, ensure that all measures are taken to prevent excessive water from flooding the unit.
10. Do not use this heat pump if any electrical part has been in contact with water. Contact an authorized installer/agent.
11. If the increase of power consumption is not due to colder weather, please consult with the local authorized installer/agent.
12. Please turn off the heat pump and disconnect it from the mains power supply, when not in use for a prolonged period of time.

11.3. Troubleshooting

Use the following troubleshooting information to resolve issues/problems with your DC Inverter heat pump.

WARNING — RISK OF ELECTRICAL SHOCK OR ELECTROCUTION.



Ensure that all high voltage circuits are disconnected before commencing heat pump installation. Contact with these circuits could result in death or serious injury to users, installers or others, due to electrical shock and may also cause damage to property.

DO NOT open any part of the heat pump as this may result to electrocution.

1. Keep your hands and hair clear of the fan blades to avoid injury.
2. If you are not familiar with your heater:
 - a) **DO NOT** attempt to adjust or service the unit without consulting your authorized installer/agent.
 - b) **PLEASE** read the complete Installation and/or User's Guide before attempting to operate service or adjust the heater.

IMPORTANT: Turn off the mains power supply to the DC Inverter heat pump prior to attempting service or repair.