

THANK YOU FOR VOTING TEXECOM

MASTER USER MANUAL

Premier 412

Premier 816

Premier 832

**Security Control Panels with Integrated
Communicator**

Issue 6



Texecom
www.texe.com

Contents

- 1. About the Alarm System 3**
 - Introduction 3**
 - About this Manual 3
 - Fire Detection 3
 - Monitoring 3
 - Zones and Partitions 3
 - Access Codes 3
 - Remote Keypads 4**
 - Keypad Types 4
 - Keypad Layouts 4
 - Function Keys 5
 - Emergency Keys 5
- 2. Operating the Alarm System 6**
 - Introduction 6**
 - Access Codes 6
 - Arming & Disarming the Alarm System 6**
 - Checking if the System is Ready to Arm 6
 - Away Arming 6
 - Stay Arming 6
 - Cancelling the Arming Process 7
 - Disarming During Entry 7
 - Disarming when not in Entry 7
 - Disarming after an Alarm 7
 - Auto Stay Arming 7
 - Changing between Delayed and Instant Stay 7
 - Arming and Disarming Partitions 8**
 - Away Arming Partitions 8
 - Stay Arming Partitions 8
 - Disarming Partitions 8
 - Changing to another Partition 9
 - Bypassing Zones 9**
 - Manually Bypassing Zones 9
 - Unbypassing Zones 9
 - Group Bypass 10
 - Quick Bypass and Arm 10
- 3. User Functions Menu 11**
 - Reset Alarms 11**
 - Last Alarm Log 11**
 - Service Faults 11**
 - Acknowledging a New Service Fault 11
 - View Service Faults 11
 - Anti-code Reset 12**
 - Toggle Chime On and Off 12**
 - Change User Code 13**
 - View Log (LCD Only) 13**
 - Abort Communications 13**
- 4. System Program Menus 14**
 - Programming Text (LCD Only) 14
 - Programming Users 15**
 - Program User (8 0) 16
 - User Options 1 (8 1) 17
 - User Options 2 (8 2) 17
 - User Options 3 (8 3) 17
 - User Text (LCD Only) (8 4) 18
 - Program Standard Users (8 5) 18
 - System Tests & Utilities 19**
 - Walk Test (9 0) 20
 - Test Speakers & Outputs (9 1) 20
 - Send Test Call (9 2) 20
 - Enable Remote/Engineer Access (9 3) 20
 - Start Call Back (9 4) 20

- Program Time (9 5) 20
- Program Date (9 6) 20
- Program Banner Text (LCD only) (9 7) 20
- Print 100 Events (9 8) 20
- Exit Program Mode (9 9) 20

- 5. Fire Safety & Maintenance 21**
 - Fire Safety 21**
 - Fire Alarm Operation 21
 - Household Fire Safety Audit 21
 - Fire Escape Planning 21
 - Maintenance 22**
 - Glossary 22**
- 6. Installation Records 23**
 - Control Panel 23
 - Keypads 23
 - Timers 23
 - Users 23
 - Zones 24

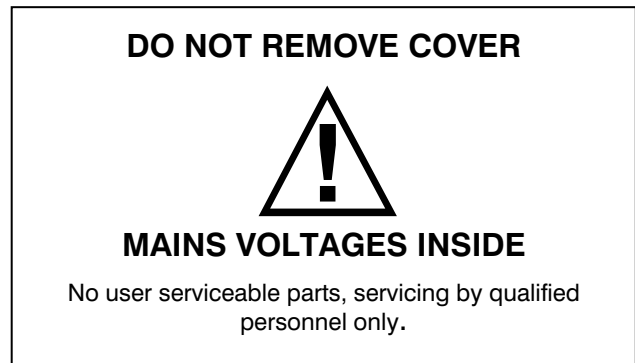

1. About the Alarm System

Introduction

Your alarm system consists of a control panel, one or more keypads and various detectors and sensors. The control panel will normally be mounted out of sight in a utility room or basement etc. The control panel houses the system's electronics and stand-by battery. There is normally no reason for anyone except an installer or service person to have access to the control panel.

The remote keypad is used to send commands to the system and to display the current system status via the various coloured lights (LED's). The keypad also provides audible feedback each time a key is pressed. Each keypad will be mounted in convenient locations inside the protected premises, near designated points of entry/exit.

Read this manual carefully and have your installer instruct you on your system's operation. Become familiar with the features that have been implemented on your system. All users of this system should be equally instructed in its use.

About this Manual

This manual is a thorough explanation of all system functions, including troubleshooting and programming Access codes in addition to performing basic system functions. Most users of the system will not need to know all of this information. The section of this manual, titled "Operating your Alarm System" explains general system concepts and instructs the user on how to arm and disarm the system and bypass zones. The remaining sections of the manual are reserved for more detailed system information.

Fire Detection

This equipment is capable of monitoring fire detection devices such as smoke detectors and providing a warning alarm if a fire condition is detected. Good fire detection depends on having adequate numbers of fire detectors placed in appropriate locations. This equipment should be installed in accordance with the relevant local authority fire regulations. Carefully review the "Fire Escape Planning" guidelines in this manual.



NOTE Your installer must enable the fire detection feature of this equipment before it will work.

Monitoring

This system is capable of transmitting alarms, troubles and emergency information over telephone lines to an alarm monitoring station. If you inadvertently initiate an alarm, immediately call the Alarm Receiving Centre (ARC) to prevent an unnecessary response.



NOTE Your installer must enable the monitoring function before it will work.

Zones and Partitions

Your installer has divided the protected premises into zones and partitions. A zone is an area of protection that has one or more detection sensors connected to it (motion detectors, glass-break detectors, door contacts or shock sensors). A single zone might be a room, a hallway or a door or window. Two or more of these zones will be linked together by the control panel to form a partition.

A partition is an area of the protected premises. A partition can be armed and disarmed independently from other partitions. All of the partitions together form the entire alarm system. If your alarm system is not divided into partitions then all devices will be assigned to Partition 1.

Some zones may belong to more than one partition, such as points of entry/exit and hallways. These are called **Global Zones** because they are not assigned to a single partition.

The following table shows the number of zones and partitions for the *Premier 412, 816 & 832* control panels:

Control Panel	Partitions	Zones	Zones (max)
<i>Premier 412</i>	2	4	12
<i>Premier 816</i>	4	8	16
<i>Premier 832</i>	4	8	32

Access Codes

As a user of the alarm system, you will be assigned a 4, 5 or 6 digit Access code. Access codes are used to arm and disarm the partition(s) to which they are assigned. Some Access codes can perform additional system functions, such as programming system options, bypassing zones and performing system tests.

Your Access code may not allow you to access certain system functions. For instance, if your code is only allowed to arm and disarm Partition 1, you will not be able to arm or disarm other partitions, or the entire system.

Your Access code may also be programmed for **Global Access**. A Global Access code can be used at any keypad and will allow you to arm and disarm any of the partitions assigned to your code. Alternatively your code may be programmed for **Partition Access**. A Partition Access code will only allow you to arm and disarm the partitions that are assigned to both the keypad and your code.

The following table shows the number of users for the *Premier 412, 816 & 832* control panels:

Control Panel	Number of Users
<i>Premier 412</i>	32
<i>Premier 816</i>	32
<i>Premier 832</i>	64

Remote Keypads

One or more remote keypads will be installed throughout the protected premises, usually one at each entry/exit door. Each remote keypad is normally assigned to the partition that it is going to control. A keypad can be assigned to more than one partition, if required (global keypad).

Keypad Types

The following keypad types are available:

Premier RKP4: The Premier RKP4 is the standard remote keypad for the Premier 412 control panel. This remote keypad has 4 zone indicator lights and four status lights (Alarm, Service, Armed and Ready).

Premier RKP8: The Premier RKP8 has same features as the Premier RKP4 but has 8 zone indicator lights. This keypad is normally used on systems that monitor up to 8 zones.

Premier RKP16: The Premier RKP16 has same features as the Premier RKP4 but has 16 zone indicator lights. This keypad is normally used on systems that monitor up to 16 zones.

Premier RKP8 Plus: The Premier RKP8 Plus has all the features of the standard Premier RKP4 plus dedicated indications for Fire, Bypass, Instant and Stay. It also features two programmable zone inputs that can be utilised by your installer for detection devices close to the location of the remote keypad. This keypad is normally used on systems that monitor up to 8 zones.

Premier RKP16 Plus: The Premier RKP16 Plus has same features as the Premier RKP8 Plus but has 16 zone indicator lights. This keypad is normally used on systems that monitor up to 16 zones.

Premier LCD: The Premier LCD has a standard size 32 character back-lit Liquid Crystal Display plus dedicated indications for Bypass, Service, Ready, Armed and Power. It also features two programmable zone inputs that can be utilised by your installer for detection devices close to the location of the remote keypad. This keypad is normally used on systems that monitor up to 32 zones.

Premier LCDL: The Premier LCDL has the same features as the Premier LCD but has a large size 32 character back-lit Liquid Crystal Display. This keypad is normally used on systems that monitor up to 32 zones.

Premier LCDP: As Premier LCD with a built in proximity tag reader.

Premier LCDLP: As Premier LCDL with a built in proximity tag reader.

Keypad Layouts

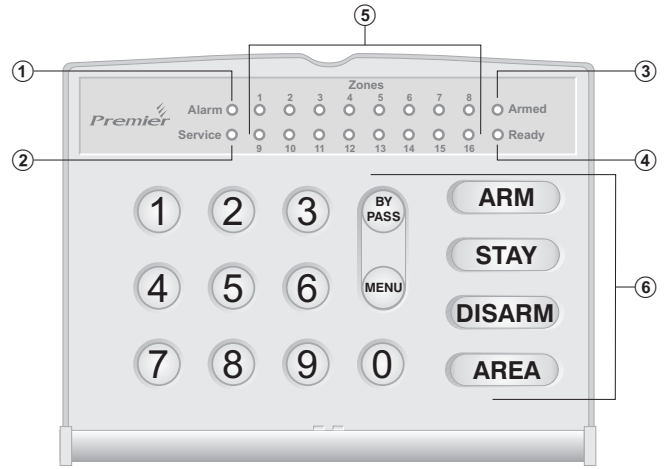

Premier RKP4/8/16

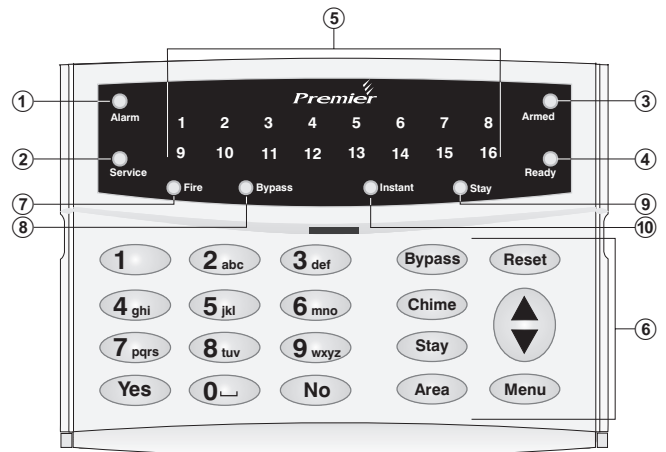

Premier RKP8/16 Plus

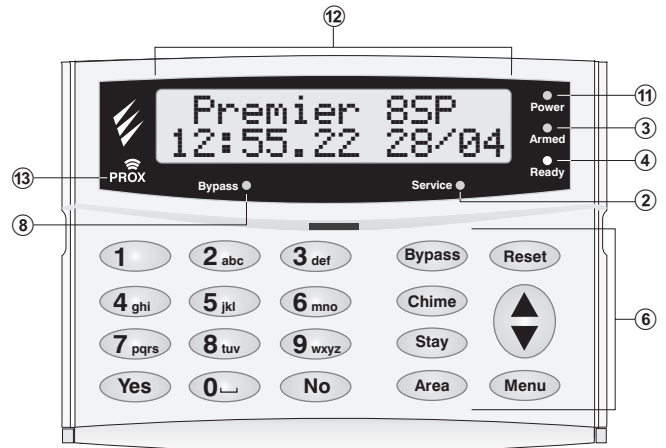











Premier LCD/LCDL/LCDP/LCDLP

- ① - **Alarm Light:** If an alarm has occurred whilst the partition/system was armed the Alarm light will illuminate.
The alarm partition/system cannot be Armed until a standing Alarm has been acknowledged/reset (see "Acknowledging an Alarm" on page 11).
- ② - **Service Light:** The Service light will flash when a new fault occurs and will change to on steady when the fault has been acknowledged. When the system is free of all faults the Service light will be off.
The alarm system cannot be armed until the new faults have been acknowledged (see "Service Faults" on page 11).
- ③ - **Armed Light:** The Armed light indicates the armed status of the partition/system. The Armed light is on when the partitions assigned to the keypad are armed. When the Armed light is off the partitions are disarmed. The Armed light will flash as follows:
Partition in Exit: Slow flash (1 second on, 1 second off).
Partition is Delayed Stay Armed: Slow flash (1 second on, 1 second off).
Partition is Instant Stay Armed: Fast flash (200 milliseconds on, 200 milliseconds off).
- ④ - **Ready Light:** If the Ready light is on the partition/system is ready for arming. If the Ready light is off, one or more zones within the partition/system are violated, check the relevant zones as indicated on the keypads. If the Ready light is flashing, one or more zones are bypassed or are violated and force-armable.
- ⑤ - **Zone Lights:** The zone lights indicate the status of each alarm zone within the partition. When a zone is violated or in trouble the relevant zone light will illuminate. When a zone is secure the relevant zone light will be off.
A keypad can be programmed to blank its display after a period of time. An Access code may be required to re-enable the display. Otherwise simply press any key.
Zone display is always enabled when the alarm system is in alarm.
- ⑥ - **Function Keys:** See "Function Keys".
- ⑦ - **Fire:** if the Fire light is on with no zone indicators illuminated, then a fire alarm has occurred from one of the 2-wire smoke sensors. If there is an accompanied zone indication, the fire alarm has occurred from the smoke sensor on the indicated zone.
- ⑧ - **Bypass:** If the Bypass light is on, one or more zones have been manually bypassed, (see "Manually Bypassing Zones" on page 9).
- ⑨ - **Stay:** If the Stay light is on, the partition/system is in the stay armed mode. The Armed light will also be flashing.
- ⑩ - **Instant:** If the Instant light is on, the partition/system is in the stay armed mode and the delayed zones (front door etc) are instant. The Armed light will also be flashing rapidly.
- ⑪ - **Power Light:** The power light is on steady when mains supply is present and flashes when the system is running on battery (mains fail).
- ⑫ - **LCD Display:** 16 character Liquid Crystal Display (LCD).
- ⑬ - **Proximity Tag Reader:** On Premier LCDP and LCDLP only.

Function Keys

The remote keypad function keys are described as follows:



Key	Function
 Bypass	The Bypass key is used for either group or manual bypass of zones (see page 9).
 Menu	The Menu key is used to access the more advanced user functions and programming options.
 Arm	The Arm key is used when away arming the system or partition.
 Stay	The Stay key is used when Stay arming the system or partition.
 Disarm	The Disarm key is used when disarming the system or partition.
 Area	The Area key is normally used when arming and disarming a particular partition. When the Area key is pressed on its own the keypad will indicate the armed status of all partitions. The Area key can also be used to temporarily switch the keypad to a different partition, see page 9.
 Chime	The Chime key is used to enable/disable the chime feature, see page 12.
 Reset	The Reset key is used to reset the system after an alarm or service fault condition, see page 11.
 Yes	The Yes key is used to arm the system and to select menu options.
 No	The No key is used when disarming the system or partition.



When a keypad is in use other keypads will be locked-out except for emergency functions. The lock-out will persist 4 seconds after the last key is pressed. Information tones will be limited to the keypad in use.

Emergency Keys

In case of emergency, the alarm system can provide three immediate emergency alarms by pressing and holding two specific keys for three seconds.

Emergency Alarm	Press Keys
 FIRE	① & ③
 POLICE	④ & ⑥
 MEDICAL	⑦ & ⑨



The emergency keys can be individually enabled or disabled for each keypad on your alarm system by the installer.

The Panic alarm can be individually programmed for either audible or silent operation for each keypad.

Emergency commands are detailed on the inside flap label of each remote keypad.

2. Operating the Alarm System

Introduction

Before attempting to operate the alarm system ensure you have familiarised yourself with all the arming and disarming methods covered in this section.

Access Codes

- If you make a mistake whilst entering your Access code, simply enter the correct Access code.

Arming & Disarming the Alarm System

Checking if the System is Ready to Arm

To help prevent faults during arming, a **Ready** light has been provided on each keypad. The **Ready** light works as follows:

- If the **Ready** light is on steady then the alarm system is ready to be armed.
- If the **Ready** light is flashing then the alarm system has bypassed zones and/or Force Armable zones that are violated, check these zones before proceeding.
- If the **Ready** light is off then one or more zones are violated, either secure or bypass these zones before proceeding. The keypads will display the zones that are violated:

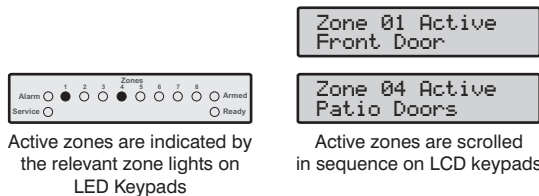

If any unbypassed zones that are not enabled for "Force Arming" are violated at the end of the exit delay this is termed an exit error and the alarm system will go into fail set state (internal alarm). If programmed by the installer the external bell will also sound. Enter a valid user Access code to silence this alarm.

A zone will only be armed when ALL associated partitions are armed but will be disarmed when ANY associated partition is disarmed.

Away Arming

The Away arming mode is normally used when leaving the premises. When the system is armed in this mode all detection zones assigned to your partition(s) will be armed.

The **Ready** light must be on steady before the alarm system can be Away armed.

► To Away arm the alarm system proceed as follows:

- Enter Access code (???)
- Press (Arm)
- Leave the premises, when the system has armed the exit tone will stop. The system is now Away armed.



If the Quick Arm feature is enabled, you can omit step 1 from the above procedure.

Stay Arming

The Stay arming mode is normally used when the premises will be occupied. When the system is armed in this mode all Interior detection zones assigned to your partition(s) will be bypassed. Before Stay arming check the following:

- Secure or bypass any perimeter zones that are violated.
- Ensure no perimeter zones are bypassed unintentionally.
- Ensure no perimeter Force Armable zones are violated unintentionally.

► To Stay arm the alarm system proceed as follows:

- Enter Access code (???)
- Press (Stay)
- The system is now Stay armed.



If the Quick Arm feature is enabled, you can omit step 1 from the above procedure.

If the system is fitted with a Premier RKP8/16 Plus then the **Stay** light will also illuminate when the system is Stay armed.

Cancelling the Arming Process

- To cancel the arming process during the exit delay:

- 1 Enter Access code (? ? ? ?)
- 2 Press (Disarm) Press (No)
- 3 Arming has been cancelled and the alarm system is now disarmed.



If the system only has one partition you will not have to perform step 2.

Disarming During Entry

- To disarm the alarm system during entry, proceed as follows:

- 1 Enter the premises via the designated entry point, the entry tone will sound. Proceed directly to the remote keypad.
- 2 Enter Access code (? ? ? ?)
- 3 The entry tone will stop and the **Armed** light will turn off. The alarm system is now disarmed.



If a valid Access code is not entered before the end of the entry delay, an alarm will occur.

Disarming when not in Entry

- To disarm the alarm system when not in entry, proceed as follows:

- 1 Enter Access code (? ? ? ?)
- 2 Press (Disarm) Press (No)
- 3 The **Armed** light will turn off. The alarm system is now disarmed.



If the system only has one partition you will not have to perform step 2.

If the Quick Disarm feature is enabled and the system is Stay armed you can omit step 1 from the above procedure.

Disarming after an Alarm

- To disarm the alarm system after an alarm, proceed as follows:

- 1 Enter Access code (? ? ? ?)
- 2 The system is disarmed and the keypads display the source of the alarm.

The system must now be reset before you can arm again, see page 11 for details on resetting alarms.

Auto Stay Arming

If your installer has enabled the Auto Stay feature the system will automatically Stay arm if the entry/exit zone (front door) is not activated whilst attempting to Away arm the system.

- To auto Stay arm your alarm system proceed as follows:

- 1 Enter Access code (? ? ? ?)
- 2 Press (Arm) Press (Yes)
- 3 Do NOT leave the premises during the exit delay. At the end of the exit delay the alarm system will Stay arm.

Changing between Delayed and Instant Stay

When Stay arming the system the delayed zones (front door etc) are normally delayed, i.e., when a delayed zone is violated it will start the entry delay timer. However, it is possible to change the delayed zones to instant when the system is in a Stay armed mode. If a delayed zone is violated when the system is in the "Instant Stay" mode the system will generate an alarm immediately.

- To change from Delayed Stay to Instant Stay, proceed as follows:

- 1 Ensure that the system is **Stay** armed.
- 2 Press and hold the (Stay) key until you hear the confirmation tone.
- 3 The **Armed** light will flash quickly. The system is **Instant Stay** armed.



If the system is fitted with a Premier RKP8/16 Plus the **Instant** light will also illuminate.

➤ To change from Instant Stay to Delayed Stay, proceed as follows:

1 Ensure that the system is **Instant Stay** armed.

2 Press and hold the **Stay** key until you hear the confirmation tone.



3 The **Armed** light will flash slowly. The system is **Delayed Stay** armed.



If your system is fitted with a *Premier RKP8/16 Plus* the **Instant** light will go off.

Arming and Disarming Partitions

This section covers arming and disarming partitions. In order to use these procedures the following requirements must be configured:

- The alarm system must be split into one or more partitions.
- Your Access code must be assigned to more than one partition.
- The keypad that you use to operate the alarm system must be assigned to multiple partitions OR your Access code is enabled for Global Access.

Away Arming Partitions

This option allows you to Away arm one or more partitions.

➤ To Away arm selected partitions, proceed as follows:

1 Enter Access code **???**



2 Press **Area**



3 The **Ready** light will flash quickly. Press **1** - **4** to select/deselect partitions, e.g. Press **2** to select Partition 2.



Partition 2 is now selected.

4 Press **Arm** Press **Yes**



The **Armed** light will flash and the exit tone will sound.

5 **Leave the area being armed**, when the partition has armed the exit tone will stop. The selected partition(s) is now Away armed.



If the Quick Arm feature is enabled, you can omit step 1 from the above procedure.

Stay Arming Partitions

This option allows you to Stay arm one or more partitions.

➤ To Stay Arm selected partitions, proceed as follows:

1 Enter Access code **???**



2 Press **Area**



3 The **Ready** light will flash quickly. Press **1** - **4** to select/deselect partitions, e.g. Press **1** to select Partition 1.



Partition 1 is now selected.

4 Press **Stay**



The selected partition(s) will arm immediately and the **Armed** light will flash.

5 The selected partition(s) is now **Stay** armed.

Disarming Partitions

This option allows you to disarm one or more partitions.

➤ To disarm selected partitions, proceed as follows:

1 Enter Access code **???**



2 Press **Area**



3 The **Ready** light will flash quickly. Press **1** - **4** to select/deselect partitions, e.g. Press **2** to select Partition 2.



Partition 2 is now selected for disarm.

4 Press **Disarm** Press **No**



5 The selected partitions are disarmed.

Changing to another Partition

Normally the remote keypad that you use will be assigned to a particular partition and therefore the zone and status lights will indicate information relevant to the assigned partition. However, you can temporarily switch the remote keypad to a different partition so that the zone and status lights indicate the information relevant to the partition that you have selected. Whilst in this mode you can also use your Access code to arm/disarm the partition you have selected (providing you have access to the selected partition).

In order to use the cross partitioning feature, it is recommended that the system is configured as follows:

- Cross partitioning must be enabled.
- The user must be assigned to multiple partitions.
- The user should be set for “Local Partition Access Only”, see page 18.
- The remote keypads should only be assigned to a single partition.

► To change to another partition, proceed as follows:

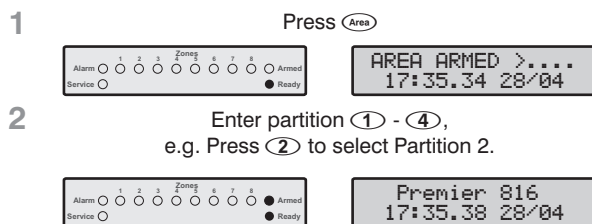

The remote keypad will now indicate information relevant to the selected partition.



After changing to the selected partition, the remote keypad will only remain in the selected partition for 10 seconds after the last key press. However if an Access code is entered whilst the remote is in this mode, the remote keypad will remain in the selected partition for 1 minute after the last key press.

Bypassing Zones

Manually Bypassing Zones

Bypassing a zone prevents it from causing an alarm.



After manually bypassing a zone, the zone will remain bypassed until the zone is manually unbypassed.

The Bypass menu will time-out if no key is pressed for 60 seconds.

► To manually bypass zones, proceed as follows:

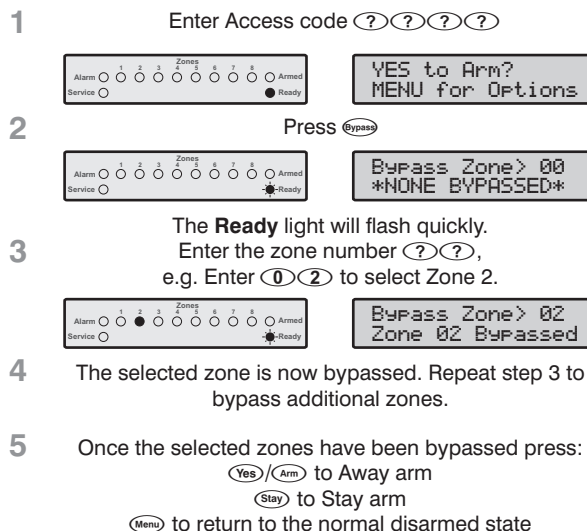

If the Quick Bypass feature is enabled, you can omit step 1 from the above procedure.

When one or more zones are bypassed the **Ready** light will flash and if the system is fitted with a *Premier RKP8/16 Plus* or LCD remote keypad then the **Bypass** light will also illuminate.

Unbypassing Zones

To manually unbypass zones, perform the manual Bypass procedure on a zone that is already bypassed.

- 24 hour zones cannot be unbypassed if they are still violated.
- If your installer has enabled the “Reinstate Bypassed Zones on Disarm” option, all zones will automatically be unbypassed each time the system is disarmed.

Group Bypass

The Group Bypass feature allows you to bypass a predefined group of zones. The alarm system has up to four groups.

► To bypass a group of zones, proceed as follows:

1 Enter Access code (?) (?) (?) (?)

2 Enter bypass group (1) - (4) followed by (Bypass)

The keypad will display the bypassed zones. If required, zones can be added or removed from the group by entering the required zone number (?) (?), e.g. Enter (0) (5) to add Zone 5.

3

4 The selected zone is now bypassed. Repeat step 3 to bypass additional zones.

5 Once the selected zones have been bypassed press:
 (Yes) / (Arm) to Away arm
 (Stay) to Stay arm
 (Menu) to return to the normal disarmed state

NOTE If the Quick Bypass feature is enabled, you can omit step 1 from the above procedure.

When one or more zones are bypassed the **Ready** light will flash and if the system is fitted with a *Premier RKP8/16 Plus* or LCD remote keypad then the **Bypass** light will also illuminate.

Quick Bypass and Arm

The Quick Bypass and Arm feature allows you to bypass a predefined group of zones and Away or Stay arm the system. The alarm system has up to four groups.

► To Quick Bypass a group of zones and Away arm, proceed as follows:

1 Enter bypass group (1) - (4)

2 Press (Arm)

The **Armed** and **Ready** lights will flash and the exit tone will sound.

3 When the exit tone stops, the system is Away armed with the selected group of zones bypassed.

► To Quick Bypass a group of zones and Stay arm, proceed as follows:

1 Enter bypass group (1) - (4)

2 Press (Stay)

The alarm system will arm immediately and the **Armed** and **Ready** lights will flash.

3 The system is Stay armed with the selected group of zones bypassed.

NOTE The Quick Arm feature must be enabled to use this feature.



3. User Functions Menu

This section covers the more advanced functions that selected users can perform with the alarm system. The following functions are available:

Reset Alarms

This function is used to reset any standing alarms and service faults. It is also used to reset detectors with a latched alarm indication, e.g., Smoke Detectors.



► To Reset Alarms, proceed as follows:

- 1 Enter Access code (? ? ? ?)

- 2 Press (Menu) (0)

- 3 The keypad will beep and the alarm system will reset all latching detectors and attempt to clear any standing **Alarms** or **Service Faults**.

Last Alarm Log

The control panel has a memory that stores the zones that caused an alarm when the system was last armed.

► To view the alarm memory, proceed as follows:

- 1 Enter Access code (? ? ? ?)

- 2 Press (Menu) (1)

The keypad will display the zones that caused an alarm when the system was last armed.

- 3 Press (Menu) to return to the normal disarmed state.

Service Faults

The response to a Service Fault condition is programmed by the installer but is normally limited to the keypad buzzer. To silence the Service Fault alarm, enter your Access code.

A flashing **Service** light indicates a new fault condition. The alarm system cannot be armed whilst a new fault exists. The **Service** light will remain flashing until the new fault is acknowledged, after which it will revert to a steady yellow and the alarm system can be armed. The **Service** light will remain steady until **all** faults have been cleared.

AC Fail and Telephone Line Fault can each have a delay programmed. The **Service** light will turn steady yellow immediately on either of these faults but no Service Fault Alarm (transmission or audible alarm) will occur unless the delay expires.



If your installer has disabled AC fail acknowledgement the **Service** light will flash "rapidly" during an AC fail condition. The system can be armed without requiring acknowledgement of this fault.

Acknowledging a New Service Fault

► New service faults can be acknowledged as follows:

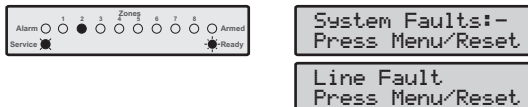
- 1 Enter Access code (? ? ? ?)

- 2 Press (Menu) (2)

The keypad will display all Service Faults.

- 3 Press (Menu) or (Reset) to acknowledge the fault and return to the normal disarmed state.

View Service Faults

► Standing faults can be viewed as follows:

1. Press the (Menu) key followed by the (2) key.
2. The keypad will display any Service Faults (see tables on next page).
3. On completion press the (Menu) key.

Service Faults Displayed on LED Keypads	
Light	Fault Condition
1	AC Fail
2	Telephone Line Fault
3	2-Wire Smoke Alarm
4	Box Tamper & Auxiliary Input: Press (4) to view type, lights 1 - 5 indicate: 1 = Box Tamper 4 = Auxiliary Tamper * 2 = Auxiliary Tamper 5 = Bell Tamper * 3 = Auxiliary PA * = UK Bell Module
5	Date or Time Lost
6	Zone Tamper/Trouble Press (6) to view zone number
7	Keypad Tamper/Removed Press (7) to view keypad number
8	Equipment Faults Press (8) to view fault type, lights 1 - 8 indicate: 1 = Output 1 Fault 2 = Output 2 Fault 3 = Siren/Bell Fault 4 = 2-Wire Smoke Sensor Fault 5 = Auxiliary Fuse Failed 6 = Battery Fault 7 = Service Timer/Zone Soak Test Failed 8 = Communication Fault

Service Faults Displayed on LCD Keypads	
LCD	Fault Condition
AC Fail	AC Fail
Line Fault	Telephone Line Fault
Smoke Alarm (2W)	2-Wire Smoke Alarm
Box/Aux Tamper	Box Tamper
Aux Tamper	Auxiliary Tamper (Aux Input)
Auxiliary Tamper	Auxiliary Tamper (UK Bell Module)
Bell Tamper	Bell Tamper (UK Bell Module)
Aux PA Alarm	Auxiliary PA (Aux Input)
Date/Time Loss	Date or Time Lost
Tamper Zone > 01	Zone Tamper/Trouble
Tamper Keypad > 1	Keypad Tamper/Removed
Output 1 Fault	Output 1 Fault
Output 2 Fault	Output 2 Fault
Siren Fault	Siren/Bell Fault
Smoke Sen. Fault	2-Wire Smoke Sensor Fault
Aux. Fuse Fault	Auxiliary Fuse Failed
Battery Fault	Battery Fault
Service Required	Service Timer/Zone Soak Test Failed
Coms Failed	Communication Fault

Anti-code Reset

This feature is normally used in the UK where users are not permitted to reset the panel following a communicated alarm. However, the user can reset the panel after entering a unique remote reset number, which is supplied by their installer or ARC.

► To perform an Anti-code Reset, proceed as follows:

- Enter Access code (? ? ? ?)
- Press (Menu) (3)

The keypad will display a randomly generated 4-digit Code.
- Contact your ARC/Installer to obtain a Anti-code Reset number.

Tel No. _____
- Enter the Anti-code Reset number given to you by your ARC/Installer (? ? ? ?).

If the code is accepted, the keypad will sound an acceptance tone and the system will reset and return to the normal disarmed state.

Toggle Chime On and Off

When a zone is enabled for Chime the keypad will generate a Chime tone every time the zone is violated. This function allows you to turn the Chime feature on and off.



► To toggle Chime on and off, proceed as follows:

- Enter Access code (? ? ? ?)
- Enter (Menu) (4)
- If Chime was off, it will turn on and the keypad will sound the Chime tone. If Chime was on, it will turn off and the keypad will sound the acceptance tone.

Change User Code

All users of the alarm system can change their own Access code number.

► To change your Access code, proceed as follows:

- 1 Enter Access code (? ? ? ?)

- 2 Enter (Menu) (5)

- 3 Enter new code (? ? ? ?)
 If the code is 4 or 5 digits **press** the (Arm)/(Yes) key to accept.

- 4 Re-enter new code (? ? ? ?)
- 5 The keypad will sound an acceptance tone if the new Access code was accepted. If you hear an error tone (low), please repeat from step 1.

View Log (LCD Only)

The control panel has an Event Log, which stores all system activity i.e., users entering their codes to arm and disarm the system, alarm events, faults etc. Each event is time and date stamped. The number of events stored in the control panel is as follows:

- Premier 412 - 750 events
- Premier 816 - 750 events
- Premier 832 - 1000 events

► To view the Event Log, proceed as follows:

- 1 Enter Access code (? ? ? ?)

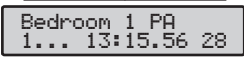
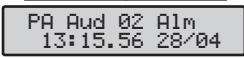
- 2 Enter (Menu) (6)
- 3



Event Type (showing Zone Text)			Event Type (Alarm Type & Zone No)		
					
Partitions	Time	Day	Time	Day/Month	

↑ Press (Arm) to toggle information displayed ↑
- 4 Press (Left Arrow) to scroll up and down through the log.
 Press (Menu) to when finished.

Abort Communications

This option aborts any communications to the Alarm Receiving Centre.

► To Abort Communications, proceed as follows:

- 1 Enter Access code (? ? ? ?)

- 2 Enter (Menu) (7)

- 3 The keypad will beep and the alarm system will abort all communications to the Alarm Receiving Centre.

4. System Program Menus

The Master User and Users with the relevant access level can access the System Program Menus. These menus allow the users access to the more advanced features and functions of the alarm system.

The following programming menus are available:

Menu	Function	Page
Programming Users		
8 0	Program User	16
8 1	User Options 1	17
8 2	User Options 2	17
8 3	User Options 3	17
8 4	User Text	18
8 5	Program Standard Users	18
System Tests and Utilities		
9 0	Walk Test	20
9 1	Test Speakers and Outputs	20
9 2	Send Test Call	20
9 3	Enable Download Access	20
9 4	Start Call Back	20
9 5	Program Time	20
9 6	Program Date	20
9 7	Program Banner Text	20
9 8	Print 100 Events	20
9 9	Exit Program Mode	20



Menus 8 0 - 8 5 are restricted to Access codes enabled for Code Programming (Master Users).

Menus 9 0 - 9 8 are restricted to Access codes enabled for User Programming.

To abort programming at any stage and preserve the original settings, press **Menu**.

The alarm system will automatically exit program mode if no key is pressed for 60 seconds.

To access the programming menu, **enter your Access code (???) and press **Menu** followed by 9**:

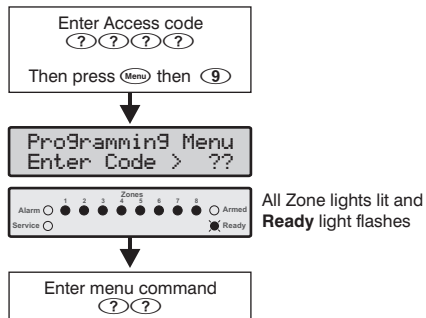

A programming menu is selected by entering a two-digit menu code. On completion of each menu option, the system reverts to the main programming menu, allowing other programming menu options to be accessed.

To exit the programming menu, **enter 9 9 or press the **Menu** key**, the system will revert to normal operation:

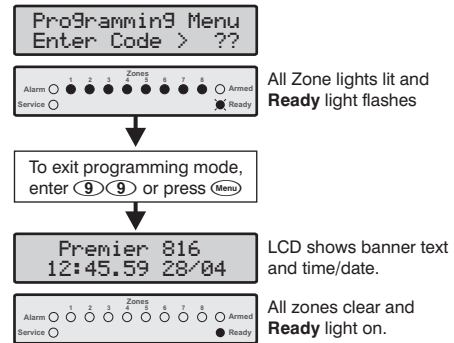

Programming Text (LCD Only)

Text is programmed in a similar way to mobile phones. Characters are selected by pressing the corresponding key the appropriate number of times (to select a character on the same key, press **↔** to move the cursor along).

The table below shows the keys to use and the characters that are assigned to them:

Key	Characters									
1	.	,	?	!	1	@	"	-	&	
2 _{abc}	a	b	c	2	A	B	C			
3 _{def}	d	e	f	3	D	E	F			
4 _{ghi}	g	h	i	4	G	H	I			
5 _{jkl}	j	k	l	5	J	K	L			
6 _{mno}	m	n	o	6	M	N	O			
7 _{pqr}	p	q	r	s	7	P	Q	R	S	
8 _{stuv}	t	u	v	8	T	U	V			
9 _{wxyz}	w	x	y	z	9	W	X	Y	Z	
0 _{..._}	_	0	,	#	*	Custom characters				
↔	Move cursor left and right									
Reset	Backspace (delete)									
Yes	Accept text									

Programming Users

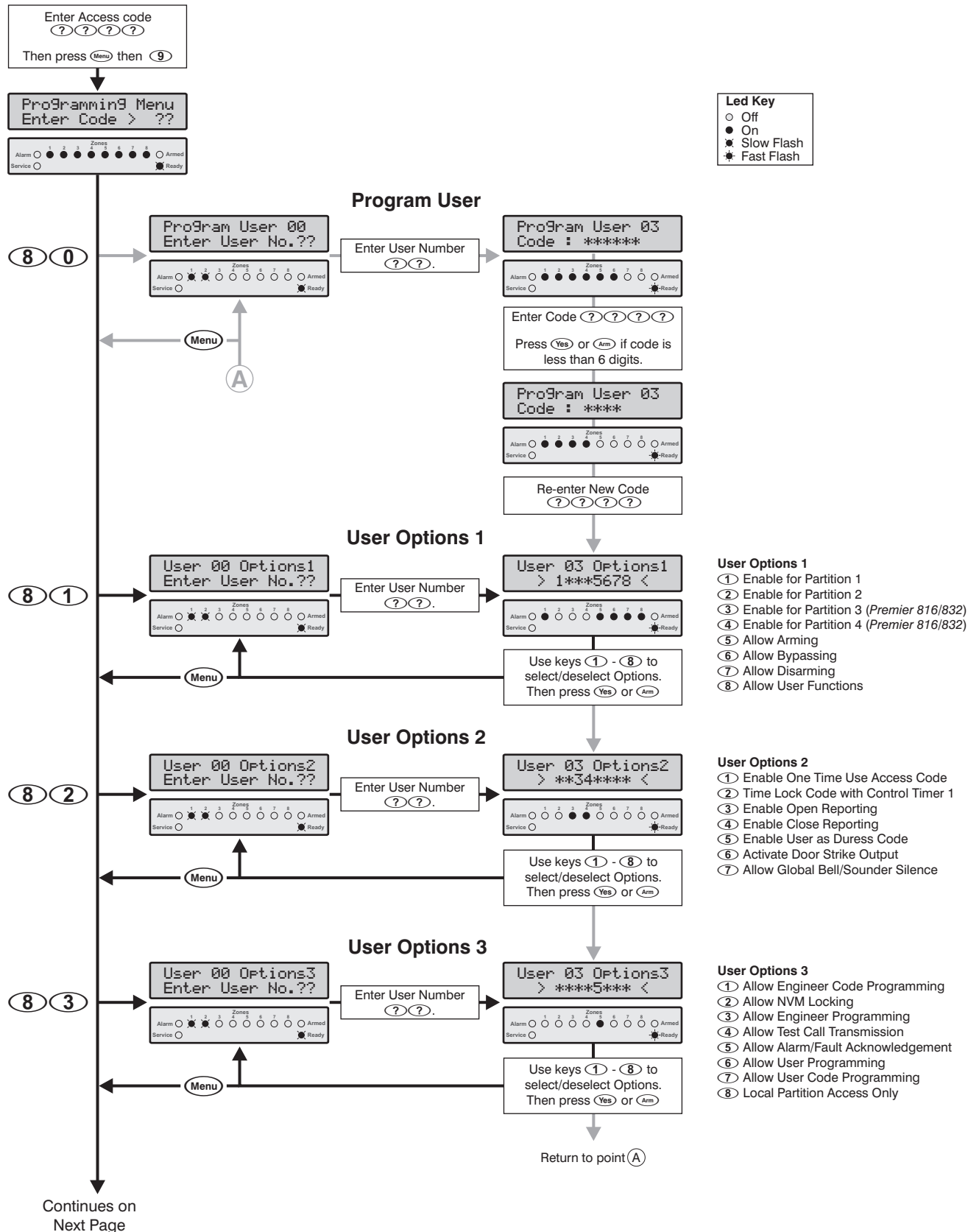

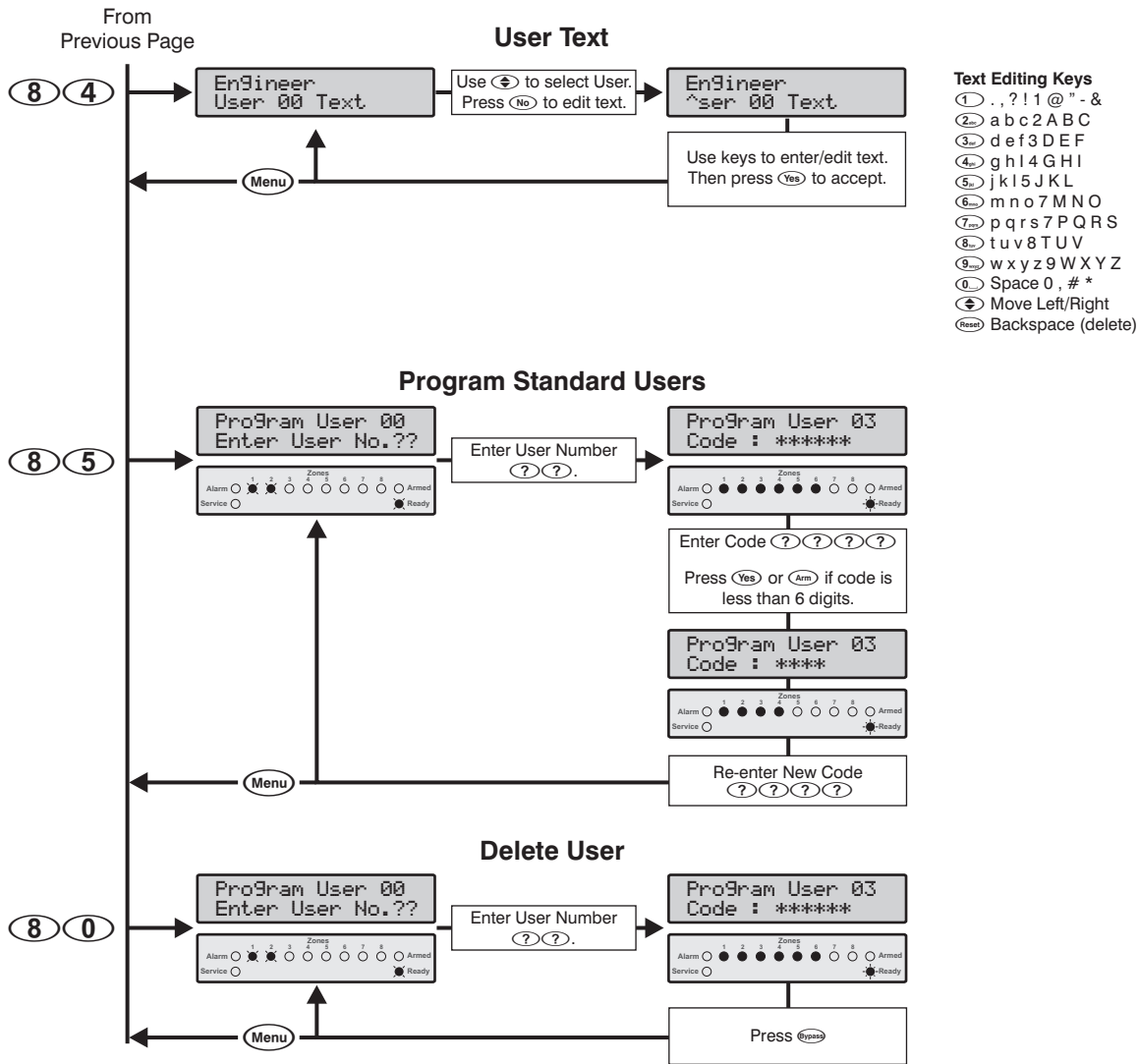

Program User

(8) (0)

The Program User option allows the master user or users with the appropriate access level to assign new users for the alarm system. The number of users (including the engineer) that are available is as follows:

- Premier 412 - 32 Users
- Premier 816 - 32 Users
- Premier 832 - 64 Users

User 00 is the Engineer and can only be accessed by the engineer code. User 01 is the Master User which has a default code of 5678. Neither of these two users can be deleted from the system.

Each user is assigned the following attributes:

- **Access Code**
This is a unique 4, 5 or 6 digit code that is assigned to the user. The system will allow a mixture of different length Access codes. The Access code must be entered at a keypad before the user can operate the alarm system.

- **User Options 1**
See User Options 1 on page 17 for details.
- **User Options 2**
See User Options 2 on page 17 for details.
- **User Options 3**
See User Options 3 on page 17 for details.
- **User Text (LCD Only)**
See User Text on page 18 for details.

User Options 1**8 1**

User Options 1 can be enabled or disabled for a selected user so that the level of access to the system may be altered. The following options are available:

1 Enable for Partition 1

On: The user can access Partition 1.

Off: The user cannot access Partition 1.

2 Enable for Partition 2

On: The user can access Partition 2.

Off: The user cannot access Partition 2.

3 Enable for Partition 3 (Premier 816/832 Only)

On: The user can access Partition 3.

Off: The user cannot access Partition 3.

4 Enable for Partition 4 (Premier 816/832 Only)

On: The user can access Partition 4.

Off: The user cannot access Partition 4.

5 Allow Arming

On: The user can arm the partitions they have been given access to.

Off: The user cannot arm any partitions.

6 Allow Bypassing

On: The user can bypass zones in partitions they have been given access to.

Off: The user cannot bypass zones.

7 Allow Disarming

On: The user can disarm the partitions they have been given access to.

Off: The user cannot disarm any partitions.



The Engineer code (User 00) can only disarm the system if the system was armed with the Engineer code.

8 Allow User Functions

On: The user can access the following user functions:

- Reset
- View Alarm Log
- View Service Faults
- Enable Chime
- Change Own Code

Off: The user cannot access the above user functions.

User Options 2**8 2**

User Options 2 can be enabled or disabled for a selected user so that the level of access to the system may be altered. The following options are available:

1 Enable One Time Use Access Code

On: The Access code can only be used once to arm and disarm the system. After the Access code has been used to disarm the system it is automatically deleted.

Off: The Access code behaves normally.

2 Time Lock Code with Control Timer 1

On: When Control Timer 1 is on, the Access code will not be accepted by the system. When Control Timer 1 is off, the Access code will be accepted by the system.

Off: The Access code will be accepted at all times.

3 Enable Open Reporting

On: The system will report an 'Open' condition to the alarm receiving centre when the Access code is used to disarm one or more partitions.

Off: The system will not report an 'Open' status.



The panel will always send an open signal after an alarm even if this option is disabled.

4 Enable Close Reporting

On: The system will report a 'Close' condition to the monitoring station when the Access code is used to arm one or more partitions.

Off: The system will not report a 'Close' condition.

5 Enable User as Duress Code

On: The Access code will report a 'Duress' condition to the monitoring station when the Access code is used.

Off: The Access code behaves normally.

6 Activate Door Strike Output

On: When a user Access code is entered, the output type "Door Strike" is activated for 2 seconds.

Off: The user Access code will not activate the "Door Strike" output.

7 Allow Global Bell/Sounder Silence

On: This option allows users to silence the bell and internal sounder for any partition, even if the user is not assigned to the partition that is in alarm. The user cannot disarm or reset the partition if they are not assigned to it.

Off: The user can only silence alarms for partitions that are assigned to their code.

User Options 3**8 3**

User Options 3 can be enabled or disabled for a selected user so that the level of access to the system may be altered. The following options are available:

1 Allow Engineer Code Programming

On: The Access code can access User 00 (Engineer) in the Program New Users menu (menu 80).

Off: The Access code cannot access user 00 in the Program New Users menu.

2 Allow NVM Locking

On: The Access code is allowed to lock/unlock the NVM (providing "Allow Engineer Programming" is enabled). Once the NVM is locked the "Load Defaults" jumper pins on the main control panel are disabled, thus preventing the panel from being defaulted.

Off: The Access code cannot lock/unlock the NVM.

③ Allow Engineer Programming

On: The Access code can access the Engineer programming menus.

Off: The Access code cannot access the Engineer programming menus.

④ Allow Test Call Transmission

On: The Access code can perform a test transmission to the monitoring station (menu 92, see page 20).

Off: The Access code cannot perform a test transmission.

⑤ Allow Alarm/Fault Acknowledgement

On: The Access code can be used to acknowledge and reset alarms and service faults. A user with this option can disarm the system after an alarm, even if the user does not have the "Allow Disarming" option.

Off: The Access code cannot be used to acknowledge and reset alarms and service faults.

⑥ Allow User Programming

On: The Access code can access the user program menus (menu 90 - 98).

Off: The Access code cannot access the user program menus.

⑦ Allow User Code Programming

On: The Access code can access users 01 to 31 in the User programming menus (menus 80 - 85).

Off: The Access code cannot access user 01 to 31 in the User programming menus.

⑧ Local Partition Access Only

On: The Access code can only be used to arm and disarm the partitions that are assigned to the remote keypad. For example, if the user is assigned to all four partitions and they use a remote keypad that is only assigned to Partition 1, they will only be permitted to arm and disarm Partition 1 at that particular remote keypad.

Off: The Access code can be used at any remote keypad (Global Access).

User Text (LCD Only)**⑧ ④**

If the system is fitted with a LCD remote keypad you can assign up to 8 characters of text to each user. This text is used when viewing the system Event Log, see page 13. User text is programmed in a similar way to mobile phones. Characters are selected by pressing the corresponding key the appropriate number of times (to select a character on the same key, press  to move the cursor along). For details on entering text, see page 14.

Program Standard Users**⑧ ⑤**

This menu option allows you to add "Standard" users to the system. The user will automatically be assigned the following options:

User Options 1: Partition 1 Access

Allow Arming

Allow Bypassing

Allow Disarming

Allow User Functions

User Options 2: Enable Open Reporting

Enable Close Reporting

Allow Global Bell/Sounder Silence

User Options 3: Allow Alarm/Fault Acknowledgement

System Tests & Utilities

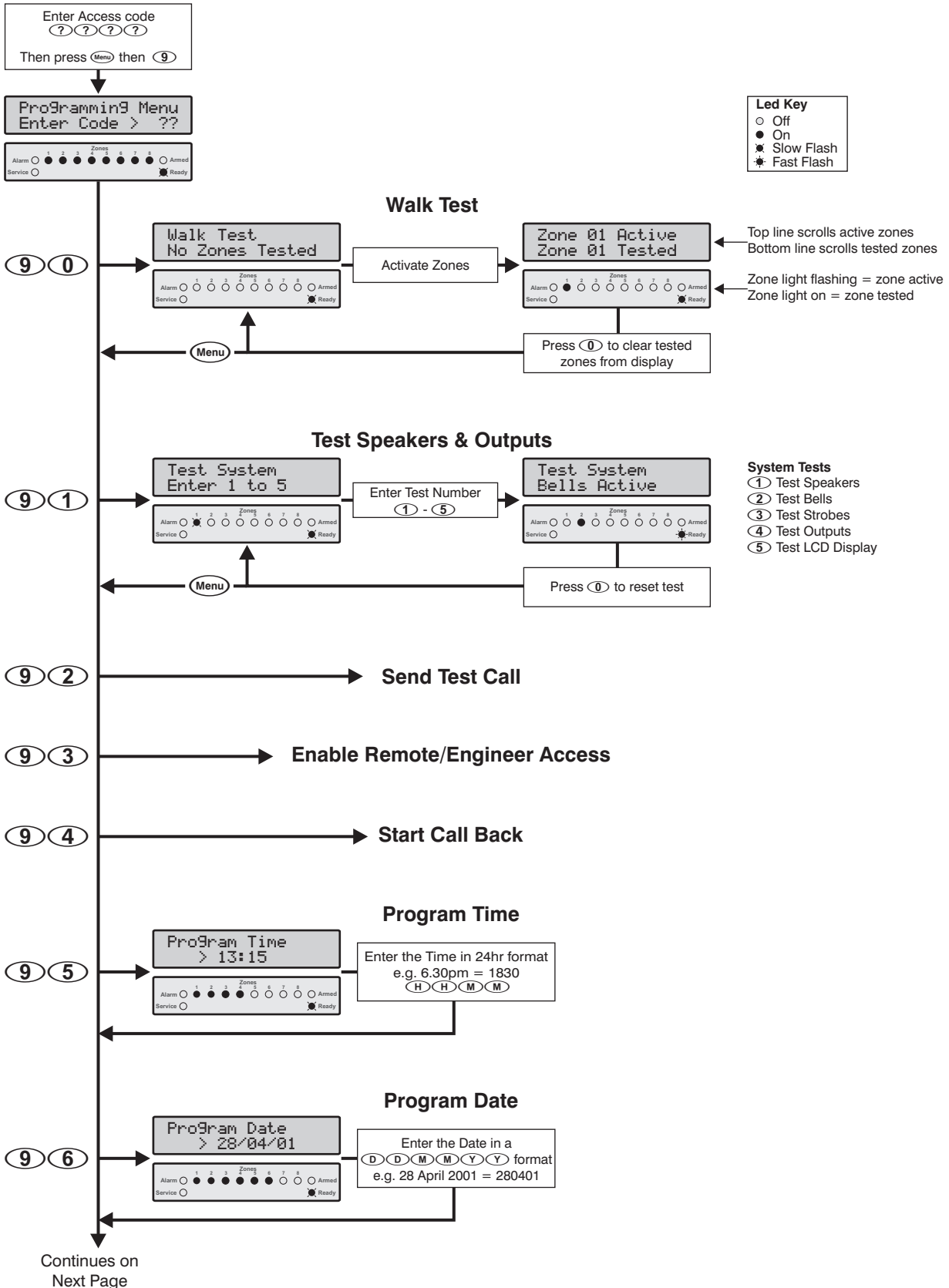

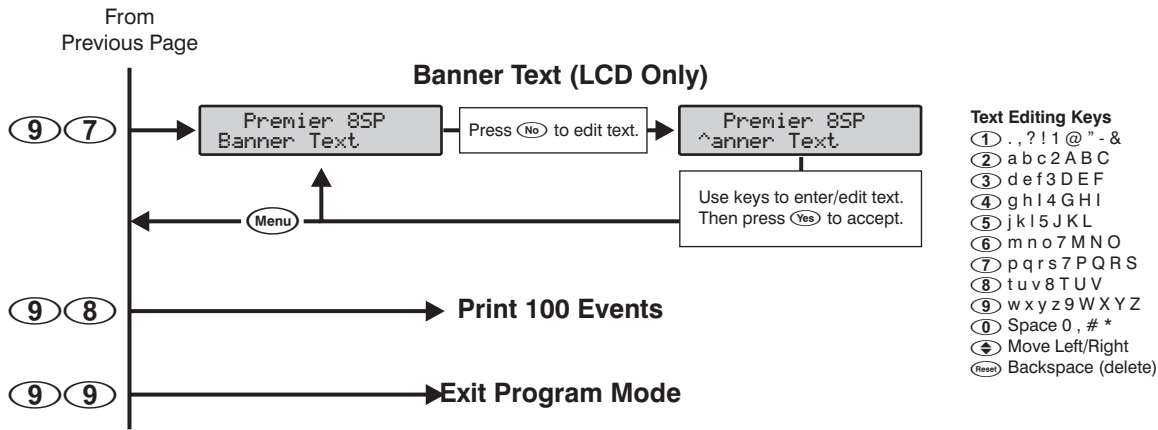

Walk Test 9 0

The Walk Test feature can only be performed when the partition is disarmed. 24 hour zones (except Fire, Tamper and Trouble) are disabled during Zone Test allowing Audible PA buttons, Silent PA buttons, etc. to be tested.

Test Speakers & Outputs 9 1

This menu options allows you to perform the following tests:

- ① Test Speakers
- ② Test Bells
- ③ Test Strobes
- ④ Test System Outputs



When performing the "Test System Outputs" option, only outputs programmed by your installer will be activated during this test.

Send Test Call 9 2

This menu options allows you to send a test call transmission to your Alarm Receiving Centre.



If the test call is unsuccessful, the keypad will sound an error tone.

Enable Remote/Engineer Access 9 3

Your alarm system may be configured in such a way that you have to authorise Remote/Engineer Access. Once authorised, your alarm system will allow:

- Your installer/Alarm Receiving Centre to access the alarm system via the remote downloading computer.
- Your installer/engineer to access the control panel programming menus.

The alarm system will allow access until 12.00am, after which, both Remote and Engineer Access will be denied.

Start Call Back 9 4

This option will cause the control panel to initiate a call back sequence. This will allow the remote downloading computer to remotely access the control panel.



You should only use this feature when requested by your installer/Alarm Receiving Centre. If the Call Back is unsuccessful the keypad will sound an error tone.

Program Time 9 5

The control panel has a real time clock that is used to date and time stamp events that are recorded within the system log. The option allows you to set the control panel time.

Program Date 9 6

The control panel has a real time clock that is used to date and time stamp events that are recorded within the system log. The option allows you to set the date on the control panel.

Program Banner Text (LCD only) 9 7

If the system is fitted with a LCD remote keypad you can assign up to 16 characters of text to the Banner Message. The Banner Message is displayed on the top line of the LCD display during the normal disarmed state. Text is programmed in a similar way to mobile phones. Characters are selected by pressing the corresponding key the appropriate number of times (to select a character on the same key, press ↔ to move the cursor along). For details on entering text, see page 14.

Print 100 Events 9 8

If your system has a printer connected, this menu option allows the last 100 events in the system Event Log to be sent to the printer.

Exit Program Mode 9 9

Selecting this menu option will log you out of programming mode and return the system to its normal state

5. Fire Safety & Maintenance

Fire Safety

Fire Alarm Operation

Alarm

On a fire alarm, the bell or siren will pulse ON and OFF. If your system is fitted with a *Premier RKP8/16 Plus* then the **Fire** light will be illuminated. The alarm is also transmitted to the Alarm Receiving Centre, if your installer has enabled this feature.





Silence

To silence the bell or siren, enter your Access code.

Resetting Smoke Detectors

Once the smoke detector is reset, if it still detects smoke, the alarm sequence will resound as described above. If there is no smoke, the system will return to normal operation.

► To reset smoke detectors, proceed as follows:

1. Enter your Access code .
2. Press the  key followed by the  key. If your system is fitted with either a *Premier RKP8/16 Plus* or LCD remote keypad then press the  key.
3. The keypad will bleep and the alarm system will reset all latching detectors.



If you suspect that a fire alarm has transmitted and that there is no fire condition, call the alarm receiving centre to avoid an unnecessary response. If a fire condition is apparent, follow your evacuation plan immediately. If the alarm sounds at night, evacuate immediately.

The description above may not be applicable depending on how your installer has programmed the fire alarm operations on your system. Ask your installer for more information regarding your system's operation.

Household Fire Safety Audit

Most fires occur in the home. To minimise the risk of fire, it is recommended that a household safety audit is conducted and a fire escape plan is developed.

- Are all electrical appliances and outlets in a safe condition? Check for frayed cords, overloaded lighting circuits, etc. If you are uncertain about the condition of your electrical appliances or household service, have a professional evaluate these units.
- Are all flammable liquids stored safely in closed containers in a well ventilated cool area? Cleaning with flammable liquids should be avoided.
- Are fire hazardous materials (matches) well out of reach of children?

- Are furnaces and wood burning appliances properly installed, clean and in good working order? Have a professional evaluate these appliances.

Fire Escape Planning

There is often very little time between the detection of a fire and the time it becomes deadly. It is therefore very important that a family escape plan be developed and rehearsed.

1. Every family member should participate in developing the escape plan.
2. Study the possible escape routes from each location within the house. Since many fires occur at night, special attention should be given to the escape routes from sleeping quarters.
3. Escape from a bedroom must be possible without opening the interior door. Consider the following when making your escape plans:
 - Make sure that all perimeter doors and windows are easily opened. Ensure that they are not painted shut and that their locking mechanisms operate smoothly.
 - If opening or using the exit is too difficult for children, the elderly or handicapped, plans for rescue should be developed. This includes making sure that those who are to perform the rescue can promptly hear the fire warning signal.
 - If the exit is above the ground level, an approved fire ladder or rope should be provided as well as training in its use.
 - Exits on the ground level should be kept clear. Be sure to remove snow from exterior patio doors in winter; outdoor furniture or equipment should not block exits.
 - Each person should know of a predetermined assembly point where everyone can be accounted for i.e. across the street or at a neighbour's house. Once everyone is out of the building, call the Fire Services.
 - A good plan emphasises quick escape. Do not investigate or attempt to fight the fire, and do not gather belongings or pets as this wastes valuable time. Once outside, do not re-enter the house. Wait for the Fire Services.
 - Write the fire escape plan down and rehearse it frequently so that should an emergency arise, everyone will know what to do. Revise the plan as conditions change, such as the number of people in the home, or if there are changes to the building's construction.

- Make sure your fire warning system is operational by conducting weekly tests (see “Fire Alarm Operation” on page 21). If you are unsure about system operation, contact your installing dealer.
- We recommend that you contact your local fire department and request further information on fire safety and escape planning. If available, have your local fire prevention officer conduct an in-house fire safety inspection.

Maintenance

With normal use, the system requires minimum maintenance. The following points should be observed.

1. Do not wash the security control panel or keypads with a wet cloth. Light dusting with a slightly moistened cloth should remove normal accumulations of dust.
2. The battery test is designed to determine battery condition. We recommend, however, that the stand-by batteries are replaced every five years.
3. For other system devices such as smoke detectors, passive infrared, ultrasonic or microwave motion detectors or glass-break detectors, consult the respective manufacturer’s literature for testing and maintenance.

Glossary

Glossary of terms used in this manual:

Access Code: A four, five or six digit code that is used to operate the alarm system.

Alarm Receiving Centre: A remote location where alarm status data is received via the telephone line from the control panel.

Bypass: A feature that allows the user to exclude selected zones from being monitored by the alarm system.

Chime: A feature that allows the keypads and internal sounder to generate a ding-dong sound whenever the selected zones are violated.

Duress Code: A special type of Access code that reports a signal to the alarm receiving centre that indicates the system is being operated under duress.

Forced Armable: An option that can be selected on a zone by zone basis, that will allow the system to be armed, even if the selected zone is violated.

Group Bypass: A feature that allows the user to bypass a group of zones in one go.

Partition: One or more zones that make up an individual area. This area can independently be armed and disarmed from other partitions.

Service: A condition that will indicate that a problem has occurred with the alarm system or with one of its detection devices.

Zone: A zone is an area of protection that has one or more detection sensors connected to it (motion detectors, glass-break detectors, door contacts or shock sensors).

6. Installation Records

Control Panel

Model:	Premier 412: <input type="checkbox"/>	Premier 816: <input type="checkbox"/>	Premier 832: <input type="checkbox"/>
Location:			

Keypads

Keypad	Location	Partitions	Fire (1 & 3)	Police (4 & 6)	Medical (7 & 9)	PA Silent	Quick Arm	Quick Disarm	Quick Bypass
1									
2									
3									
4									
5									
6									

Timers

Timer	Partition 1	Partition 2	Partition 3	Partition 4
Exit Time	Sec.	Sec.	Sec.	Sec.
Entry Delay 1 Time	Sec.	Sec.	Sec.	Sec.
Entry Delay 2 Time	Sec.	Sec.	Sec.	Sec.
Alarm Delay Time	Min.	Min.	Min.	Min.
Bell Delay Time	Min.	Min.	Min.	Min.
Bell Duration Time	Min.	Min.	Min.	Min.

Users

No.	Name	No.	Name	No.	Name	No.	Name
00	Engineer	16		32		48	
01	Master	17		33		49	
02		18		34		50	
03		19		35		51	
04		20		36		52	
05		21		37		53	
06		22		38		54	
07		23		39		55	
08		24		40		56	
09		25		41		57	
10		26		42		58	
11		27		43		59	
12		28		44		60	
13		29		45		61	
14		30		46		62	
15		31		47		63	

Zones

No.	Location	Partitions	B	C	No.	Location	Partitions	B	C
1					17				
2					18				
3					19				
4					20				
5					21				
6					22				
7					23				
8					24				
9					25				
10					26				
11					27				
12					28				
13					29				
14					30				
15					31				
16					32				

B = Bypass; C = Chime

Installation Company: _____

Address: _____

Telephone: _____

Fax: _____

Email: _____

Alarm Receiving Centre: _____

Account No: _____

Telephone: _____

Email: _____

Texecom
www.texe.com

© Texecom Ltd. 2000 - 2003

Premier Endstation and Keypads are protected by UK and International
 Registered Design.

Registered Design Numbers: 2041830, 2047440 and 2089016

INS141-6